



US Catalog

Softstarters

Type PSR, PSE and PSTX

Motors use almost one third of the world's generated electricity. So it is safe to say that reliable motor operation is crucial to our modern way of life.

Yet millions of these motors are not run optimally. The wear and tear associated with frequent starts and stops cause unplanned stoppages and shortened operational lifetime. The uptime of full-speed motors would be greatly improved if softstarters were used. As the name implies, softstarters enable smooth motor

starting and stopping, thus optimizing both new and existing motors. For motor protection on a global scale, by simply using softstarters, this could have a major impact in taking control of the processes around us.



ABB softstarters

Table of contents

ABB softstarters	1
PSR – The compact range	2
PSE – The efficient range	3
PSTX – The advanced range	4
Fieldbus communication	5
Marketing material and tools	6

ABB softstarters

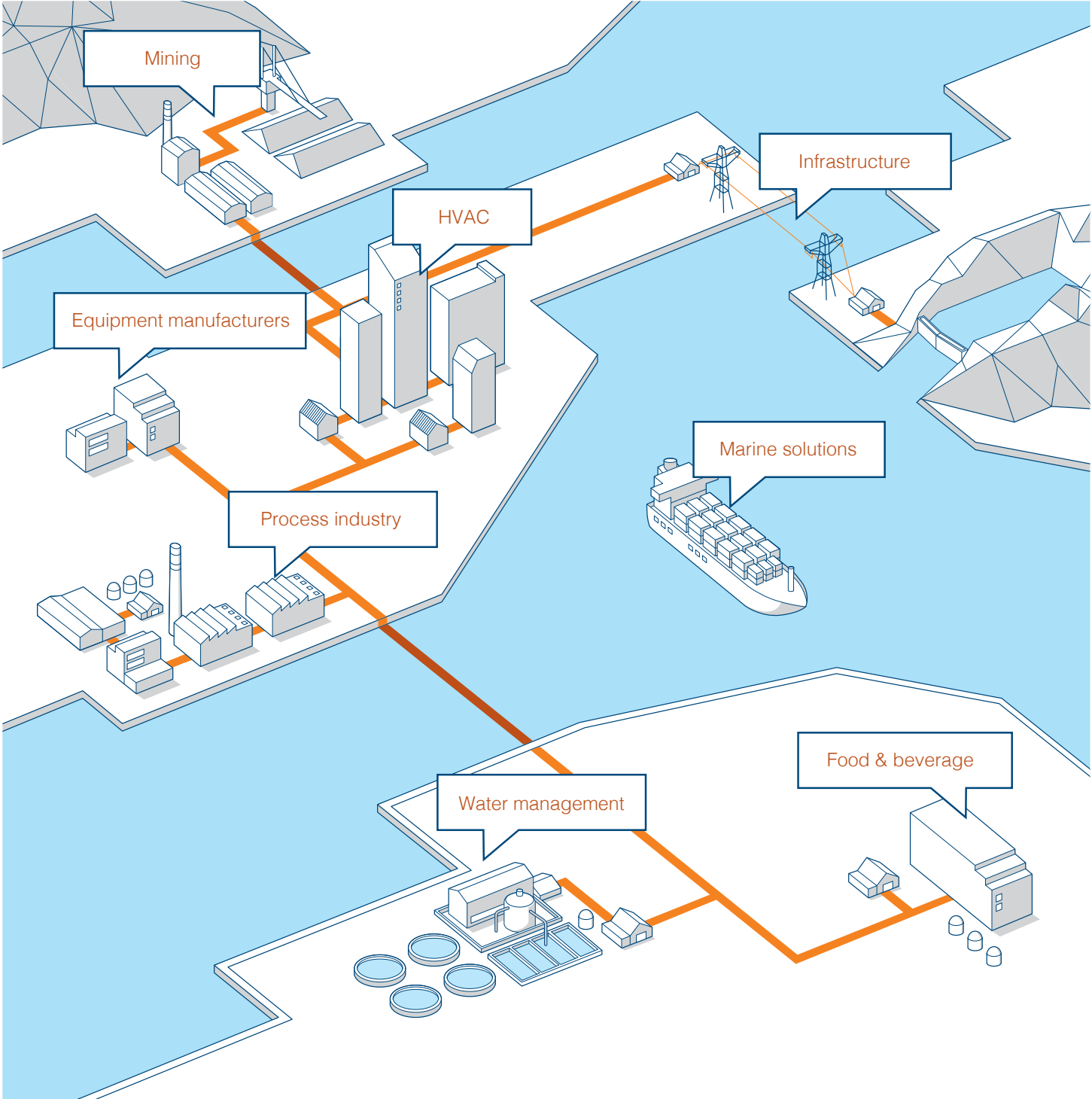
How we are helping the industry

1

Softstarters from ABB offer multiple values and benefits. Whether you are a consultant, OEM, panel builder or end-user, softstarters will add to your business value by securing motor reliability, improving installation efficiency and increasing application productivity.

Secure motor Reliability

ABB softstarters help increase your motor's lifetime by protecting it from electrical stress. Starting currents are easily optimized to your load, application and motor size. Over ten motor protection features are included to keep your motor safe from different load and network irregularities.

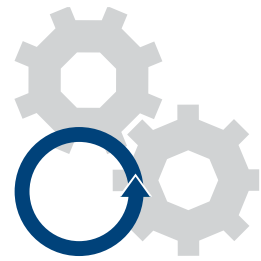

Improve installation Efficiency

Reduce your installation time and panel size by having all the features you need built into your softstarter. Our softstarters are easy to install thanks to their compact design and many built-in features. The built-in bypass saves energy and space while reducing heat generation—a complete motor starting solution in one unit.



Increase application Productivity

Reduce the number of stops in your production by allowing your softstarter to do more than just starting. Our softstarters reduce the mechanical stress on your motor application, which will increase your uptime. Torque control, pump cleaning, motor brake and many other features enable you to operate your process at its full potential.





Xylem - South Africa ABB softstarters provide efficiency in the mining industry

One of Xylem's water solutions helps to prevent flooding in mines. Previous softstarters needed a lot of extra protection equipment. Xylem was looking for a simpler solution that would ensure reliability even at a depth of 3,500 meters. Reducing the number of components by 80 percent shortened installation time by 60 percent. By cutting costs in half, Xylem can sell twice as many panels with softstarters than before.

Why softstarting matters to Xylem

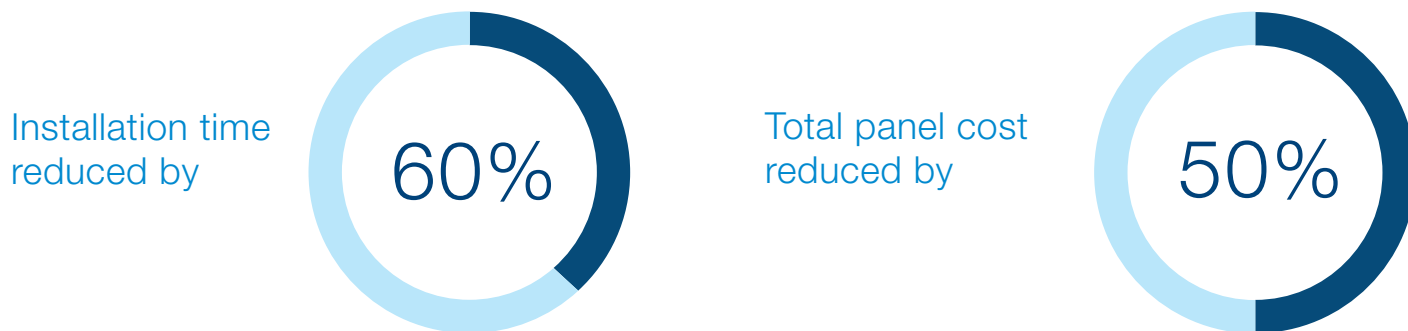

For more examples of how ABB softstarters are helping the industry, visit www.abb.com/lowvoltage/launches/pstx.

ABB softstarters

Improving industrial processes around the globe

1

Softstarters can do wonders for your operations. Packed with useful features, they reduce the wear of your equipment, improve the reliability of your processes, and increase overall productivity.

Controlling pumps

Eliminating water hammering with torque control

Water hammering is a common problem with pumps. It typically results in a lot of wear on pipes and valves when stopping the pump. ABB softstarters feature torque control stop which eliminates water hammering and prolongs the lifetime of the system, while reducing pump downtime.

Keep pipes and pumps clean

There is a risk of pumps clogging over time. This will cause reduced flow and increased risk of pump damage. Thanks to the feature that reverses the direction of the flow and starts again with kick-start, ABB softstarters can help prevent and solve pump clogging and associated downtime.

Avoid running dry with underload protection

Damage due to pumps running dry can be avoided with the softstarter feature underload protection. It stops the motor which saves the pump from additional wear and contributes to prolonging its lifetime.

Controlling fans

Soft starting adjusted to application

Fans normally have a high moment of inertia, which makes starting tough and current high. If an ABB softstarter is used, the voltage is increased gradually during start, which reduces the current and removes the inrush peak. It is possible to adjust the settings to fit almost any starting condition, from unloaded to fully loaded.

Fast stops with motor braking

It can also take a long time to stop the fan. Active braking using the dynamic brake feature reduces stopping times. This improves process safety when the load has a high moment of inertia thereby making fan operation easier for the operator.

Avoid unwanted movements with stand-still brake

An idle fan that is rotating backwards due to wind or airflow from another fan can be kept still using the stand-still brake. It prevents unwanted airflow and improves the control of the system without the need for an external mechanical brake.

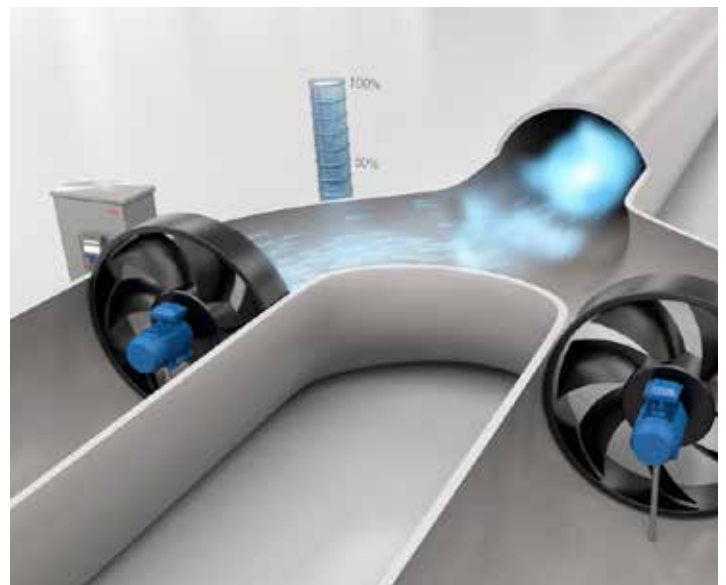

Controlling conveyor belts

Avoid overheating with overload protection

Too much material on a conveyor belt may cause overload and overheating, reducing the reliability and longevity of the motor. The ABB overload protection feature shuts down the motor in case of overload, avoiding overheating.

Increased flexibility with jog with slow speed

After stopping the belt, it may be necessary to run the motor at low speed to correctly position the belt before resuming operation. The jog with slow speed feature makes it possible to position the belt manually, in both forward and reverse, before restarting the belt. This improves process efficiency and eliminates the need for a variable speed drive, which is a considerably more expensive solution.

Continuous operation with limp mode

Shorted thyristor is a possible problem for a softstarter, putting it out of operation until the component has been replaced. Using limp mode, the softstarter will continue to work with one thyristor shorted, avoiding costly unplanned stoppages.



Controlling compressors

Full control of current with current limit

Many applications are sensitive to high or variable starting currents. The feature current limit makes it possible to start the motor securely even in a weaker network, improving the availability of the equipment and system. Reducing the current means reducing the stress on cables, the network, and motor.

Full voltage start for scroll compressors

For scroll compressors it is often necessary to start the motor in a very short time while still maintaining a low starting current. Full voltage start is a start mode that gives you almost a direct start but without the current peak.

Phase reversal protection for problem-free commissioning

A motor rotating in the wrong direction, which may occur due to incorrectly connecting the phases, may cause severe damage to a compressor. Using phase reversal protection, the motor won't start in the wrong direction, avoiding costly compressor downtime and repairs.



ABB softstarters

Why motor starting and stopping matters

1

There are some common issues associated with starting and stopping electrical motors. Depending on the requirements, different starting and stopping methods can be used.



Direct-on-line

Direct-on-line starting (DOL, also across the line starting) is the easiest and most commonly used starting method. It is suitable for stable networks and mechanically stiff and well-dimensioned shaft systems due to the high current and torque generated during start.

DOL starting is uncontrolled, which means that the motor will start with maximum current and torque regardless of load type.



Star-delta

A star-delta starter reduces current and torque during start. The starting current is about one third compared to direct-on-line starting, although it also reduces the starting torque to about 25 percent.

Star-delta is not adjustable, so if the torque is reduced too much, the motor will not start. Current peaks will happen when switching from star to delta connection.



Softstarter

Like direct-on-line and star-delta starters, softstarters are used to start and stop motors in full-speed applications. It eliminates common problems associated with motor starting and stopping, including electrical surges, spikes and high inrush currents.

Because it offers soft starting and stopping, a softstarter is the optimal compromise between a direct-on-line or star-delta starter and a variable speed drive in many full-speed motor applications.

Torque

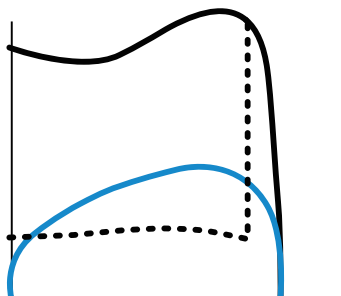

Motor current

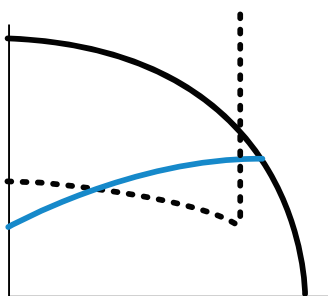

— DOL
- - - Star-delta
— Softstarter

Typical torque and current curves from starting a motor using DOL, star-delta and softstarter.

Variable speed drive

Like a softstarter, a variable speed drive (VSD) can perform soft motor starting and stopping. However, the VSD was designed primarily to control motor speed, resulting in energy efficient motor operation in variable speed applications.

Using a VSD with the sole purpose of ensuring soft starting and stopping of full-speed motors is an unnecessary solution.

ABB softstarters

A solution for every need

The ABB softstarter offering consists of three ranges, covering every need. Our products help you secure motor reliability, improve installation efficiency and increase application productivity.



PSR – The compact range

Technical data:

Rated motor current	3...105 A
Main motor voltage	208...600 V
Control supply voltage	100...240 V AC or 24 V AC/DC

PSE – The efficient range

Technical data:

Rated motor current	30...370 A
Main motor voltage	208...600 V
Control supply voltage	100...250 V AC

PSTX – The advanced range

Technical data:

Rated motor current	30...1250 A (inside delta: 2160 A)
Main motor voltage	208...690 V
Control supply voltage	100...250 V AC

Softstarter feature selection guide

	Current limit	Current limit ramp and dual current limit	Electronic motor overload protection	Dual overload protection	Underload protection	Power factor protection	Locked rotor underload protection	Current/voltage protection	Phase reversal protection	Customer defined protection	Motor heating	PTC/PT100 input for motor protection	Overvoltage/undervoltage protection	Earth-fault protection	Built-in bypass	Inside-delta connection possible	Graphical display and keypad	Detachable keypad	Motor runtime and start count	Programmable warning functions	Diagnostics	Overload time-to-trip	Overload time-to-cool	Analog output	Fieldbus output	Event log	Multiple languages	Electricity metering	Torque control	Torque limit	Coated PCB	Limip mode	Jog with slow speed forward/reverse	Dynamic brake	Stand still brake	Sequence start	Full voltage start	Kick start	Automatic pump cleaning	
PSR	-	-	-	-	-	-	-	-	-	-	-	-	•	-	-	-	-	-	-	-	-	-	-	o	-	-	-	-	-	-	-	-	-	-	-	-	-	-	-	
PSE	•	-	•	-	•	-	•	-	-	-	-	-	•	-	•	-	-	-	-	-	-	-	•	o	o	-	-	•	-	•	-	-	-	-	-	-	-	•	-	
PSTX	•	•	•	•	•	•	•	•	•	•	•	•	•	•	•	•	•	•	•	•	•	•	•	•	•	•	•	•	•	•	•	•	•	•	•	•	•	•	•	•
	Secure motor reliability												Improve installation efficiency										Increase application productivity																	

• Standard o Optional - Not available

ABB softstarters

A part of your motor starting solution

1

Motor starting requires several components to work perfectly together. ABB is a one-stop shop for motor starting, offering all the necessary components and complete motor starting solutions, proven by the numerous installations worldwide.



1 Softstarter

- Soft start and stop with reduced current
- Features to improve process productivity
- Detachable keypad for front door mounting on a panel



2 Short circuit breaker MCCB

- Short circuit protection of motor
- Possibility for electrical isolation

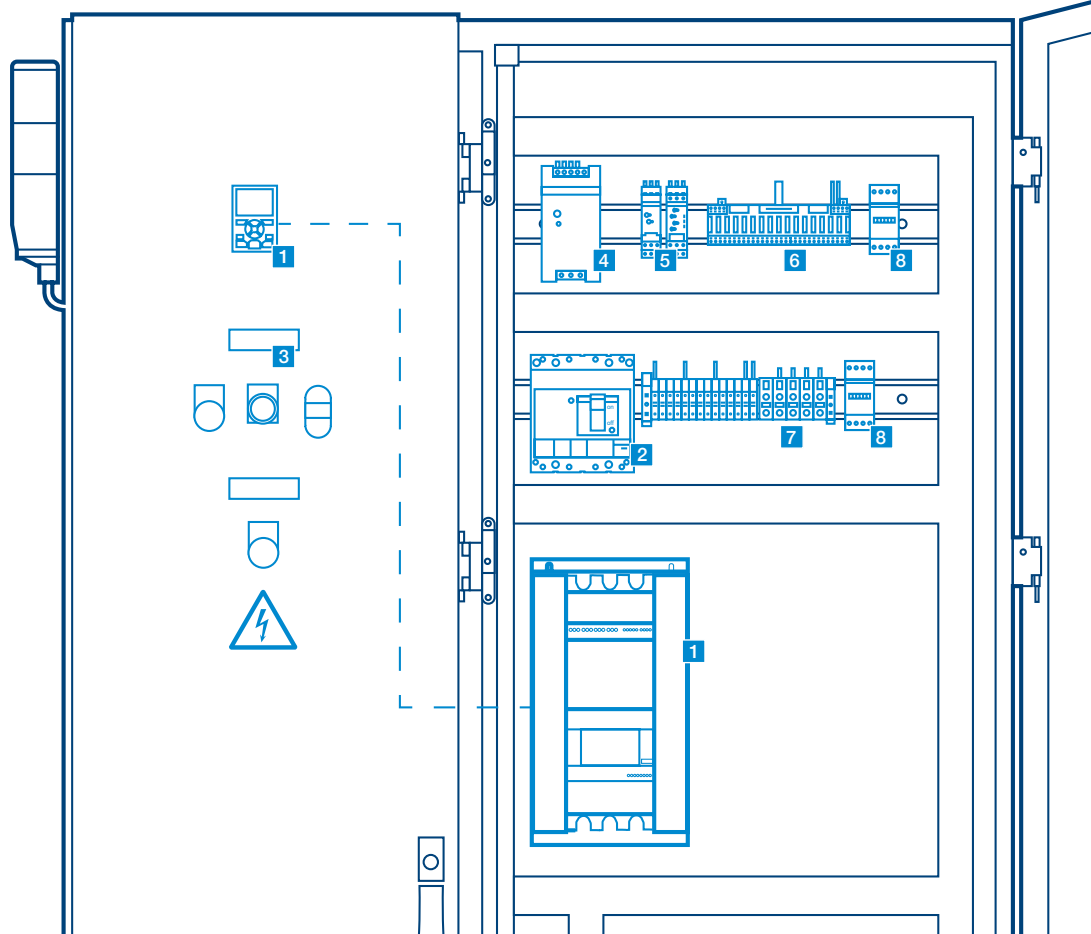

Can I use a softstarter for an ATEX motor?

ABB softstarters PSR, PSE and PSTX can be used to start ATEX classified motors in Ex environments if the following considerations are taken into account:

- The softstarter has to be placed outside the Ex area, either in another location or inside an ATEX approved panel.
- A separate ATEX approved overload relay from ABB must be used together with a line contactor. This overload relay will replace the built-in EOL in the softstarter and has an ATEX approved tripping curve.
- Select softstarter according to normal or heavy-duty start depending on application and line contactor and overload relay with Type 2 coordination.





- 3 Pilot devices**
- Remote control of motor
 - Indication of softstarter and motor status with light and sound
 - Emergency stop of motor



- 4 Power supply CP-E**
- Possible to use 24 V AC/DC equipment in the panel, e.g. PLC



- 5 Liquid level monitoring relays CM-ENS**
- Monitoring and signalling the water level



- 6 PLC 800M**
- Automatic control
 - Remote communication



- 7 Terminal blocks SNK range**
- Easy installation of control wires



- 8 Line contactor AF**
- Isolation at stop
 - Isolation at faults
 - Emergency stop
 - Back-up DOL starter

Can I use a softstarter on a ship?

ABB softstarters PSE and PSTX have marine approvals and are certified for marine environment.

Ships use IT networks, which means there is a floating electrical ground. It is possible to use an ABB softstarter in such a network, but it is recommended to not connect the functional earth or ground on the softstarter to the ship to avoid disturbances from the network to that would affect the electronics inside the softstarter.



ABB softstarters

Wall mounting instructions

1

Softstarter, type	Minimum distance to wall mm (in)			
	A	B	C	D
PSR				
PSR3...PSR16	0	0	25 (0.98)	N/A
PSR25...PSR30	0	0	25 (0.98)	N/A
PSR37...PSR45	0	0	25 (0.98)	N/A
PSR60...PSR105	0	0	25 (0.98)	N/A
PSE				
PSE18...PSE105	100 (3.94)	10 (0.39)	20 (0.79)	N/A
PSE142...PSE170	100 (3.94)	10 (0.39)	20 (0.79)	N/A
PSE210...PSE370	100 (3.94)	10 (0.39)	20 (0.79)	N/A
PSTX				
PSTX30...PSTX105	100 (3.94)	10 (0.39)	20 (0.79)	35 (1.38)
PSTX142...PSTX170	100 (3.94)	10 (0.39)	20 (0.79)	35 (1.38)
PSTX210...PSTX370	100 (3.94)	10 (0.39)	20 (0.79)	35 (1.38)
PSTX470...PSTX570	150 (5.91)	15 (0.59)	20 (0.79)	35 (1.38)
PSTX720...PSTX840	150 (5.91)	15 (0.59)	20 (0.79)	35 (1.38)
PSTX1050...PSTX1250	150 (5.91)	15 (0.59)	20 (0.79)	35 (1.38)

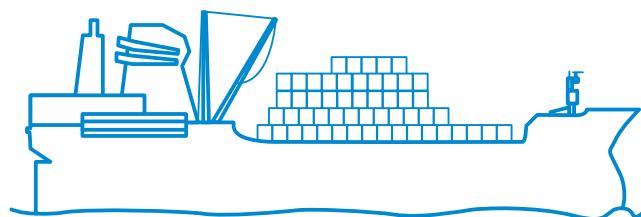
Minimum distance to front

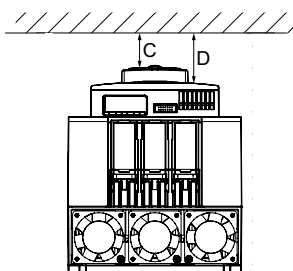

Minimum distance to wall

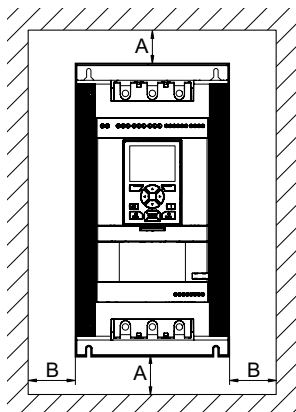

Maximum mounting angle

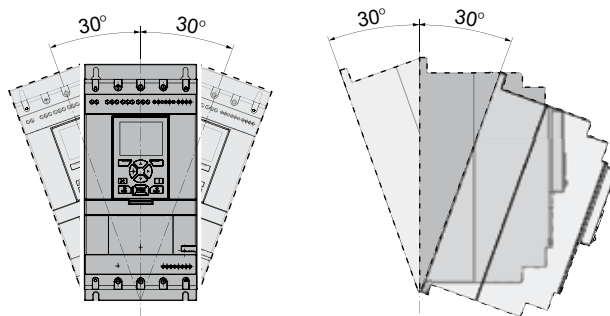

Items included in the box with the softstarter











	Multi-language manual	Terminal kit	Cable and mounting kit for detachable keypad
PSR3...PSR105	•	-	-
PSE18...PSE370	•	•	-
PSTX30...PSTX1250	•	•	•

ABB softstarters

Certifications and approvals

The table below shows the certifications and approvals for ABB softstarters.
For other certifications and/or approvals, please contact ABB.

Certifications and approvals

Abbreviation approved in	Certifications						Approvals: ship classification societies				
											
	CE EU	cULus Canada USA	CCC China	EAC Russia	ANCE Mexico	C-tick Australia	ABS	GL	Lloyd's Register	DNV	CCS
PSR3... PSR105	•	•	•	•	-	•	-	-	-	-	-
PSE18... PSE370	•	•	•	•	•	•	•	•	•	•	•
PSTX30... PSTX370	•	•	•	•	•	•	•	•	•	•	•
PSTX470... PSTX570	•	•	•	•	•	•	Pending	Pending	Pending	Pending	Pending
PSTX720... PSTX1250	•	•	Pending	•	•	•	Pending	Pending	Pending	Pending	Pending

• **Standard design approved**, the products bear the certification mark when it is required.

Directives and standards

No. 2006/95/EC	Low voltage equipment
No. 2004/108/EC	Electromagnetic compatibility
EN 60947-1	Low voltage switchgear and control gear—Part 1: General rules
EN 60947-4-2	AC semiconductor motor controllers and starters
UL 508	Industrial Control Equipment
CSA C22.2 No 14	Industrial Control Equipment



PSR – The compact range

PSR - The compact range

Introduction	2/2
Overview	2/4
Ordering details	2/5
Accessories	2/6
Technical data	2/7
Dimensions	2/8
Circuit diagrams	2/9

PSR – The compact range

Introduction

2



The PSR softstarter is the most compact of all the softstarter ranges, which allows for the design of compact starting equipment. A PSR together with a manual motor starter makes up a far more compact starting solution than a star-delta starter, and with the built-in bypass, the energy losses inside the softstarter are highly reduced.

- Two-phase controlled
- Operational voltage: 208...600 V AC
- Wide rated control supply voltage: 100...240 V AC, 50/60 Hz or 24 V AC/DC
- Rated operational current: 3...105 A
- Soft start with voltage ramp
- Soft stop with voltage ramp
- Built-in bypass for energy saving and easy installation
- Easy set-up by three potentiometers
- Fieldbus communication with FieldBusPlug adapter and the FieldBusPlug
- Run and Top of Ramp relays available for monitoring
- Connection kits available for connection to ABB manual motor starters (MMS)

Secure motor Reliability

Reduce the electrical stresses and keep the motor protected with the MMS

The PSR reduces the starting current for the motor. The possibility of connecting it to the manual motor starter makes it possible to build a compact and complete starting solution with overload and short-circuit protection.

Improve installation Efficiency

Saving time and money with built-in bypass and easy set-up

On the PSR, the bypass is built-in and verified by ABB, saving you time during installation and providing more space in your panel. Set-up is done through three potentiometers making it very fast and easy.

Increase application Productivity

Reduce the mechanical stresses on your motor

Soft start and stop with PSR will reduce mechanical wear and tear on the application and increase the availability and uptime.

PSR – The compact range

Introduction

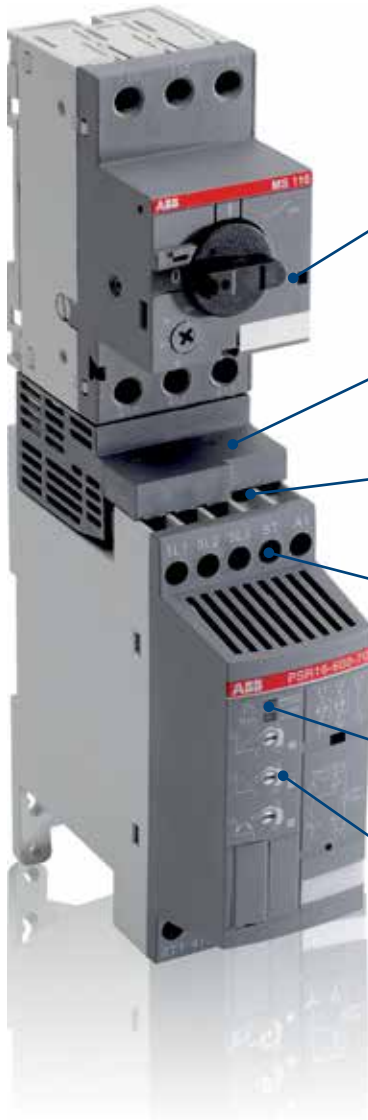

Motor protection with manual motor starter

Use the PSR together with the MMS to get a complete motor starter with soft start and stop together with overload and short circuit protection.



Connection kit (optional)

The connection kits simplifies installation of the PSR by making the connection to the MMS screwless.



Screw or DIN-rail mounted

PSR is fast and easy to install by using screw mounting or DIN-rail mounting (PSR3...PSR45).



Output signal relays

PSR has output relays for Run and Top of ramp (PSR25...PSR105).



LED indicators

PSR has LED indicators for On/Ready and Run/Top of ramp.



Three potentiometers for settings

Set-up is made very easy with only three potentiometers, for start ramp time, stop ramp time and initial/end voltage level.

Settings

- ① Start = 1...20 sec
- ② Stop = 0...20 sec - including the step down voltage
Step down = 2% reduction for each second increased stop ramp
- ③ U_{ini} = 40...70% results in end voltage = 30...60%

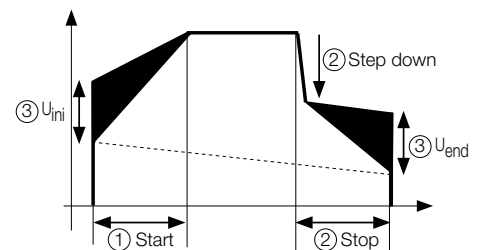
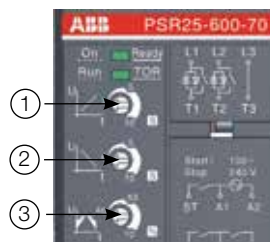

PSR – The compact range

Overview

2



Normal start In-line connected	PSR3	PSR6	PSR9	PSR12	PSR16	PSR25	PSR30	PSR37	PSR45	PSR60	PSR72	PSR85	PSR105
(400 V) kW	1.5	3	4	5.5	7.5	11	15	18.5	22	30	37	45	55
IEC, max. A	3.9	6.8	9	12	16	25	30	37	45	60	72	85	105
(440-480 V) hp	2	3	5	7.5	10	15	20	25	30	40	50	60	75
UL, max. FLA	3.4	6.1	9	11	15.2	24.2	28	34	46.2	59.4	68	80	104
UL coordination	600 V, 40 °C												
J-type fuses for UL coordination ¹⁾	Max. fuse, J-type (85 kA)												
	J-35			J-60			J-90		J-110	J-125	J-150	J-200	
UL listed circuit breaker ¹⁾	Please see coordination tables at: applications.it.abb.com/SOC or at new.abb.com/low-voltage/products/softstarters/pstx .												
IEC coordination	400 V, 40 °C												
Using manual motor starters type 1 coordination will be achieved. ¹⁾	Manual motor starter (50 kA)												
	MS116			MS132			MS450			MS495		—	
Using gG fuses type 1 coordination will be achieved. ¹⁾	Fuse protection (50 kA) gG Fuse												
	10 A	16 A	25 A	32 A	50 A	63 A	100 A	125 A	200 A	250 A			
Suitable switch fuse for the above gG fuses. ¹⁾	Switch fuse												
	OS32G					OS125G			OS250				
Overload protection is used to protect the motor from overheating. ¹⁾	Thermal overload relay												
	TF42DU					TA75DU			TA110DU				
The line contactor is not required for the softstarter itself but often used to open if OL trips. ¹⁾	Line contactor												
	AF9		AF12	AF16	AF26	AF30	AF38	AF52	AF65	AF80	AF96	AF116	

¹⁾ This is an example of coordination. For more examples see: applications.it.abb.com/SOC.

PSR – The compact range

Ordering details



Description

Selection table for normal start.

Typical applications:

- Bow thruster
- Centrifugal pump
- Compressor
- Conveyor belt (short)
- Elevator



For a more precise selection, use the online softstarter selection tool available by scanning the shown QR code or using the selection tool available at:

new.abb.com/low-voltage/products/softstarters



PSR3 ... PSR16



PSR25 ... PSR30



PSR37 ... PSR45



PSR60 ... PSR105

Rated operational voltage U_n , 208...600 V AC

Rated control supply voltage, U_c , 100...240 V AC, 50/60 Hz

IEC				UL/CSA					Catalog number	Global reference code	Weight (1 pce)	
Rated operational power			current	Rated operational power				current			kg	(lb)
230 V	400 V	500 V		200 / 208 V	220 / 240 V	440 / 480 V	550 / 600 V					
P_n kW	P_n kW	P_n kW	I_n A	P_n hp	P_n hp	P_n hp	P_n hp	FLA A				
0.75	1.5	2.2	3.9	0.5	0.75	2	2	3.4	PSR3-600-70	1SFA896103R7000	0.45	(0.99)
1.5	3	4	6.8	1	1.5	3	5	6.1	PSR6-600-70	1SFA896104R7000	0.45	(0.99)
2.2	4	4	9	2	2	5	7.5	9	PSR9-600-70	1SFA896105R7000	0.45	(0.99)
3	5.5	5.5	12	3	3	7.5	10	11	PSR12-600-70	1SFA896106R7000	0.45	(0.99)
4	7.5	7.5	16	3	5	10	10	15.2	PSR16-600-70	1SFA896107R7000	0.45	(0.99)
5.5	11	15	25	7.5	7.5	15	20	24.2	PSR25-600-70	1SFA896108R7000	0.65	(1.43)
7.5	15	18.5	30	7.5	10	20	25	28	PSR30-600-70	1SFA896109R7000	0.65	(1.43)
7.5	18.5	22	37	10	10	25	30	34	PSR37-600-70	1SFA896110R7000	1.00	(2.20)
11	22	30	45	15	15	30	40	46.2	PSR45-600-70	1SFA896111R7000	1.00	(2.20)
15	30	37	60	20	20	40	50	59.4	PSR60-600-70	1SFA896112R7000	2.20	(4.85)
22	37	45	72	20	25	50	60	68	PSR72-600-70	1SFA896113R7000	2.27	(5.00)
22	45	55	85	25	30	60	75	80	PSR85-600-70	1SFA896114R7000	2.27	(5.00)
30	55	55	105	30	40	75	100	104	PSR105-600-70	1SFA896115R7000	2.27	(5.00)

Rated operational voltage U_n , 208...600 V AC

Rated control supply voltage, U_c , 24 V AC/DC

0.75	1.5	2.2	3.9	0.5	0.75	2	2	3.4	PSR3-600-11	1SFA896103R1100	0.45	(0.99)
1.5	3	4	6.8	1	1.5	3	5	6.1	PSR6-600-11	1SFA896104R1100	0.45	(0.99)
2.2	4	4	9	2	2	5	7.5	9	PSR9-600-11	1SFA896105R1100	0.45	(0.99)
3	5.5	5.5	12	3	3	7.5	10	11	PSR12-600-11	1SFA896106R1100	0.45	(0.99)
4	7.5	7.5	16	3	5	10	10	15.2	PSR16-600-11	1SFA896107R1100	0.45	(0.99)
5.5	11	15	25	7.5	7.5	15	20	24.2	PSR25-600-11	1SFA896108R1100	0.65	(1.43)
7.5	15	18.5	30	7.5	10	20	25	28	PSR30-600-11	1SFA896109R1100	0.65	(1.43)
7.5	18.5	22	37	10	10	25	30	34	PSR37-600-11	1SFA896110R1100	1.00	(2.20)
11	22	30	45	15	15	30	40	46.2	PSR45-600-11	1SFA896111R1100	1.00	(2.20)
15	30	37	60	20	20	40	50	59.4	PSR60-600-11	1SFA896112R1100	2.20	(4.85)
22	37	45	72	20	25	50	60	68	PSR72-600-11	1SFA896113R1100	2.27	(5.00)
22	45	55	85	25	30	60	75	80	PSR85-600-11	1SFA896114R1100	2.27	(5.00)
30	55	55	105	30	40	75	100	104	PSR105-600-11	1SFA896115R1100	2.27	(5.00)

PSR – The compact range

Accessories

2



PSR16-MS116

1SFC132168R0001



PSR30-MS132

1SFC13224R0001



PSR45-MS450

1SFC132170R0001



PSR105-MS495

1SFC132238R0002



PSR-FAN3-45A

1SFC132171R0001



PSR-FAN60-105A

1SFC132258R0001



PSLW

1SFC1320128R0002



PS-FBPA

1SFC132168R0001

For softstarter type	Catalog number	Global reference code	Pkg qty	Weight (1 pce)	
				kg	(lb)
Connection kit					
PSR3...PSR16 with MS116 or MS132	PSR16-MS116	1SFA896211R1001	1	0.022	(0.049)
PSR25...PSR30 with MS132-12 ... MS132-32	PSR30-MS132	1SFA896212R1001	1	0.040	(0.088)
PSR37...PSR45 with MS450	PSR45-MS450	1SFA896213R1001	1	0.034	(0.075)
PSR60...PSR105 with MS495	PSR105-MS495	1SAM501903R1001	1	0.050	(0.110)

For softstarter type	Catalog number	Global reference code	Pkg qty	Weight (1 pce)	
				kg	(lb)
Fan					
PSR3...PSR45	PSR-FAN3-45A	1SFA896311R1001	1	0.010	(0.022)
PSR60...PSR105	PSR-FAN60-105A	1SFA896313R1001	1	0.013	(0.029)

For softstarter type	Catalog number	Global reference code	Pkg qty	Weight (1 pce)	
				kg	(lb)
Terminal enlargements					
PSR60...PSR105	PSLW-72	1SFA899002R1072	1	0.150	(0.033)
Wire range mm ² 1 x 10...50 mm ² , 2 x 10...25 mm ²					

For softstarter type	Catalog number	Global reference code	Pkg qty	Weight (1 pce)	
				kg	(lb)
FieldBusPlug connection accessory					
PSR3...PSR105	PS-FBPA	1SFA896312R1002	1	0.060	(0.132)

PSR – The compact range

Technical data

Softstarter types	PSR3	PSR6	PSR9	PSR12	PSR16	PSR25	PSR30	PSR37	PSR45	PSR60	PSR72	PSR85	PSR105
Rated insulation voltage U_i	600 V												
Rated operational voltage U_e	208...600 V +10%/-15%, 50/60 Hz ±5%												
Rated control supply voltage U_s	100...240 V AC, 50/60Hz ±5% or 24 V AC/DC, +10%/-15%												
Starting capacity at I_e	4 x I _e for 6 sec.												
Number of starts per hour	See table below for details												
standard	10 ¹⁾												
with aux. fan	20 ¹⁾												
Ambient temperature													
during operation	-25...+60 °C (-13...+140 F) ²⁾												
during storage	-40...+70 °C (-40...+158 F)												
Maximum altitude	4000 m (13123 ft) ³⁾												
Degree of protection													
main circuit	IP20							IP10					
control circuit	IP20												
Power consumption													
Supply circuit													
at 100...240 V AC	12 VA							10 VA					
at 24 V AC/DC	5 W												
Max. Power loss at rated I_e	0.7 W	2.9 W	6.5 W	11.5 W	20.5 W	25 W	36 W	5.5 W	8.1 W	3.6 W	5.2 W	7.2 W	6.6 W
Connectable cable area													
main circuit	1 x 0.75...2.5 mm ² (19...14 AWG)					1 x 2.5...10 mm ² (14...8 AWG)		1 x 6...35 mm ² (10...2 AWG)		1 x 10...95 mm ² (8...4/0 AWG)			
	2 x 0.75...2.5 mm ² (19...14 AWG)					2 x 2.5...10 mm ² (14...8 AWG)		2 x 6...16 mm ² (10...6 AWG)		2 x 6...35 mm ² (10...2 AWG)			
control circuit	1 x 0.75...2.5 mm ² (19...14 AWG)					1 x 0.75...2.5 mm ² (19...14 AWG)		2 x 0.75...1.5 mm ² (19...16 AWG)					
	2 x 0.75...2.5 mm ² (19...14 AWG)					2 x 0.75...1.5 mm ² (19...16 AWG)							
Signal relays for run signal													
resistive load	3 A					3 A							
AC-15 (contactor)	0.5 A					0.5 A							
for top of ramp signal													
resistive load	-					3 A							
AC-15 (contactor)	-					0.5 A							
LED													
for On/Ready	Green												
for Run/Top of ramp	Green												
Settings													
Ramp time during start	1...20 sec.												
Ramp time during stop	0...20 sec.												
Initial and end voltage	40...70%												

¹⁾ Valid for 50% on time and 50% off time. If other data is required, contact your local ABB office.
²⁾ Above 40 °C (104 °F) up to max. 60 °C (140 °F) reduce the rated current with 0.8% per °C (0.44% per °F).
³⁾ When used at high altitudes, above 1000 meters (3281 ft) up to 4000 meters (13123 ft), de-rate the rated current using the following formula.

$$\left[\% \text{ of } I_e = 100 - \frac{X-1000}{150} \right] \times = \text{actual altitude of the softstarter in meter.} \quad \left[\% \text{ of } I_e = 100 - \frac{Y-3280}{497} \right] y = \text{actual altitude of the softstarter in feet.}$$
For derating of voltage, contact your local ABB office.

Number of starts per hour using PSR softstarters

Motor current I _e	Starts/hour without auxiliary fan							Starts/hour with auxiliary fan										
	10	20	30	40	50	60	80	100	10	20	30	40	50	60	80	100		
3 A	PSR3							PSR6										
6 A	PSR6			PSR9				PSR9										
9 A	PSR9		PSR12			PSR16		PSR25		PSR9			PSR12					
12 A	PSR12		PSR16		PSR25		PSR30			PSR12		PSR16		PSR25				
16 A	PSR16		PSR25		PSR30		PSR37			PSR16		PSR25		PSR30				
25 A	PSR25		PSR30		PSR37			PSR45		PSR25		PSR30		PSR37		PSR45		
30 A	PSR30		PSR37		PSR45		PSR60		PSR30		PSR37		PSR45					
37 A	PSR37		PSR45		PSR60		PSR72		PSR85		PSR105							
45 A	PSR45		PSR60		PSR72		PSR85		PSR105		-							
60 A	PSR60		PSR72		PSR85		PSR105		-		-							
72 A	PSR72		PSR85		PSR105		-		-		-							
85 A	PSR85		PSR105		-		-		-		-							
105 A	PSR105		-		-		-		-		-							

Data based on an ambient temperature of 40° (104 °F), starting current of 4 x I_e and ramp time 6 seconds. For more optimized selection or to use PSR for heavy-duty starts, please use the softstarter selection tool.

PSR – The compact range

Dimensions

2

PSR3...PSR16

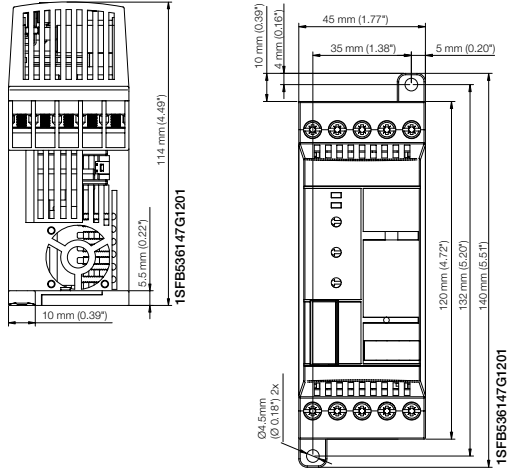

PSR37...PSR45

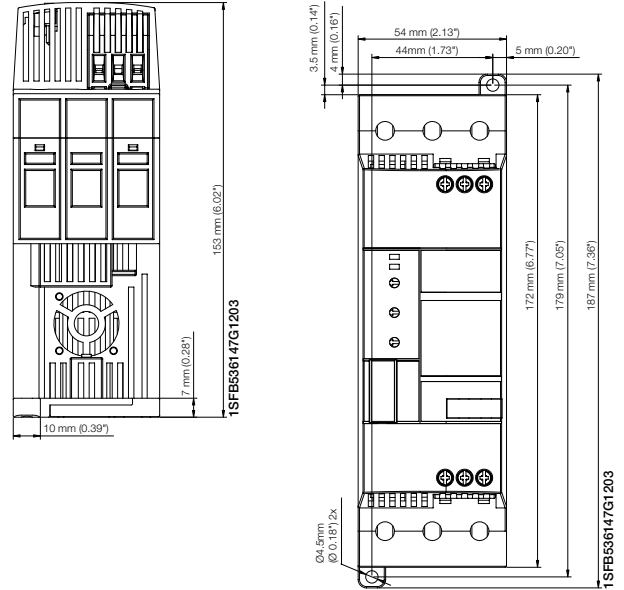

PSR25...PSR30

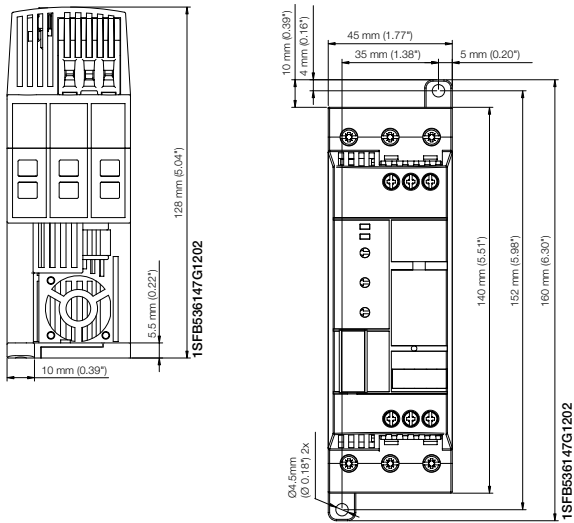

PSR60...PSR105

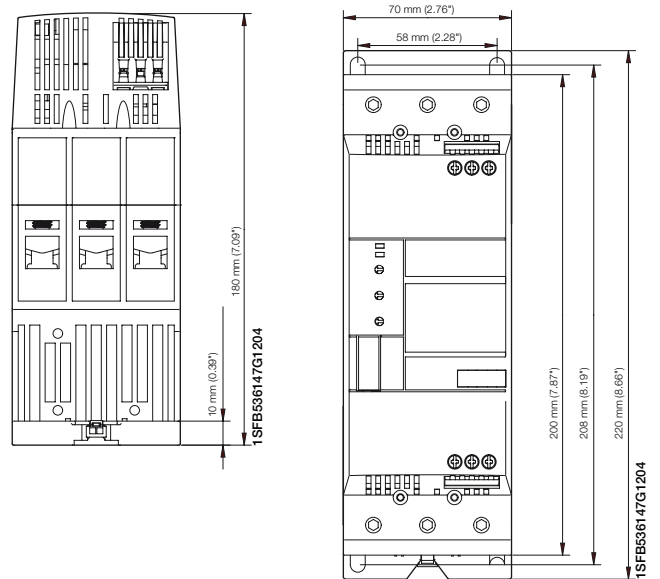

Dimensions in mm (and in)

PSR – The compact range

Circuit diagrams

PSR3...PSR16 With MMS

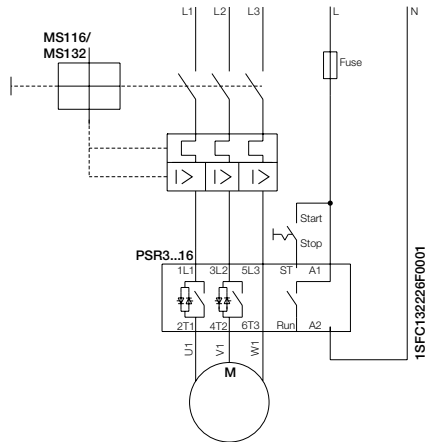

With MMS and auxiliary contact

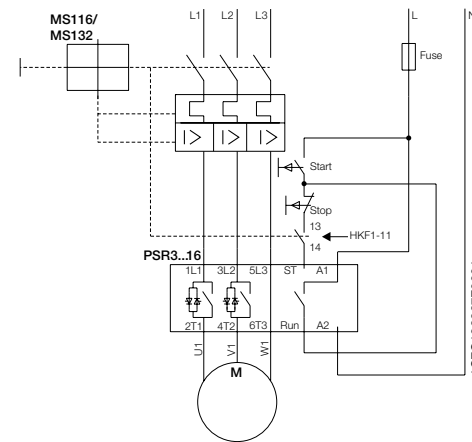

With fuses, contactor and O.L.

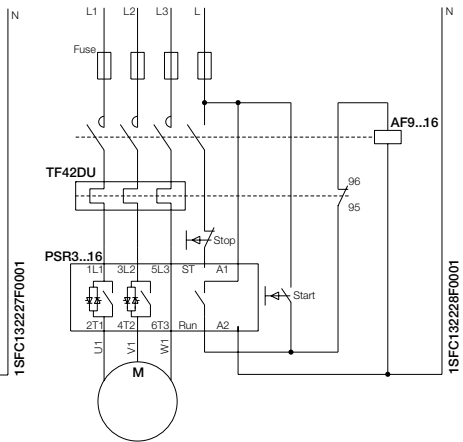

PSR25...PSR45 With MMS

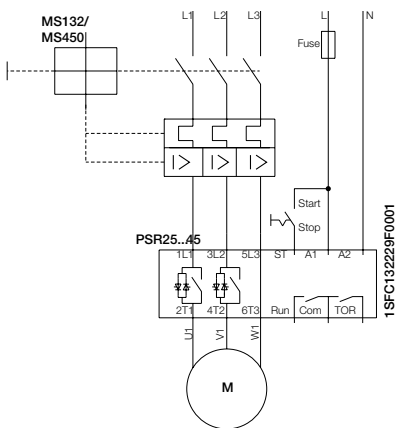

With MMS and auxiliary contact

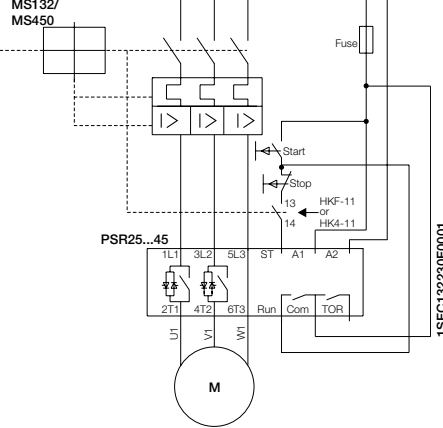

With fuses, contactor and O.L.

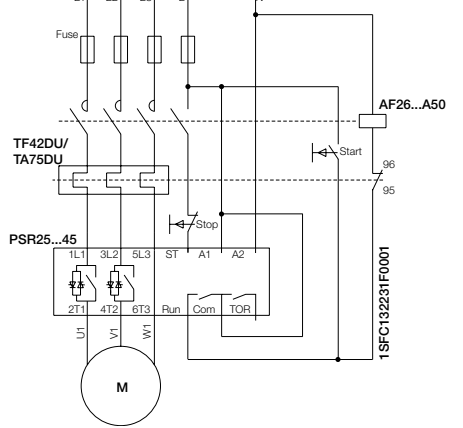

PSR60 ... PSR105 With MMS

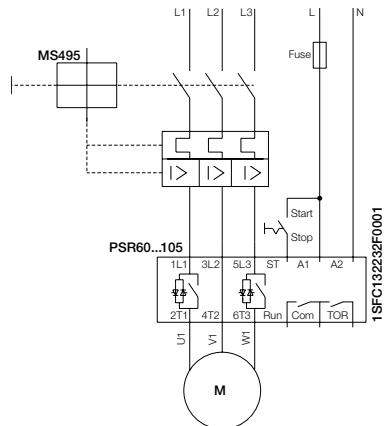

With MMS and auxiliary contact

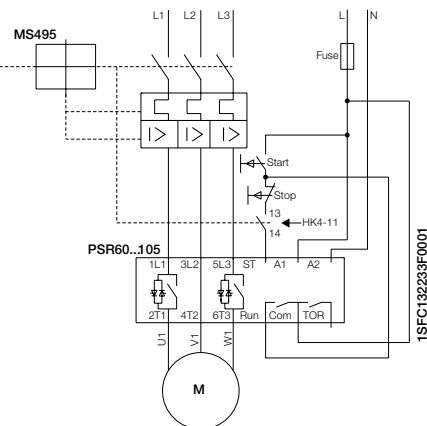

With fuses, contactor and O.L.

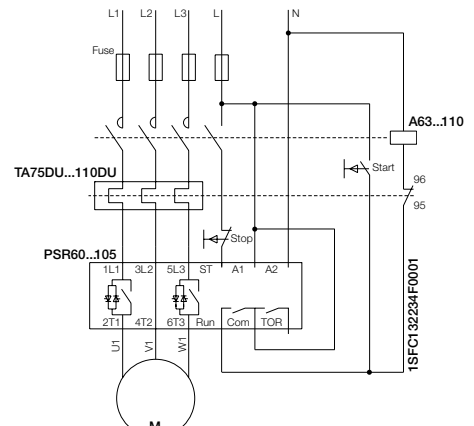



PSE –The efficient range

PSE - The efficient range

Introduction	3/2
Overview	3/4
Ordering details	3/6
Accessories	3/8
Technical data	3/9
Dimensions	3/12
Circuit diagrams	3/13

PSE – The efficient range

Introduction



3

The PSE has been designed to meet the most common requirements from the water management sector, and is specialized in pump operation. It combines the requested protections with a very compact design and built-in bypass. Remote operation with external keypad or over fieldbus is available as an option.

- Two-phase controlled
- Operational voltage: 208...600 V AC
- Wide rated control supply voltage: 100...250 V AC, 50/60 Hz
- Rated operational current: 18...370 A
- Voltage ramp and torque control for both start and stop
- Current limit
- Kick-start
- Built-in bypass for energy saving and easy installation
- Coated PCBA protecting from dust, moist and corrosive atmosphere
- Illuminated display that uses symbols to become language neutral
- External keypad rated IP66 (Type 1, 4X,12) as an option
- Fieldbus communication with FieldBusPlug adapter and the FieldBusPlug
- Analog output for display of motor current
- Electronic overload protection
- Underload protection
- Locked rotor protection

Secure motor Reliability

Basic motor protection and current limit

The PSE includes the most important protections for handling different load situations that can happen to pumps e.g. overload and underload. The current limit gives you more control of the motor during start and allows you to start your motor in weaker networks.

Improve installation Efficiency

Saving time and money with built-in bypass and compact design

On the PSE, the bypass is built-in and verified by ABB, saving you time during installation and providing space in your panel. The keypad is language neutral and illuminated for easy set-up and operation in field. The compact design makes installation fast and easy.

Increase application Productivity

Torque control for elimination of water hammering in pumps

Torque control is the most efficient way to stop a full speed pump. The PSE has a special torque stop ramp that is designed together with a pump manufacturer to eliminate water hammering in an optimal way.

PSE – The efficient range

Introduction



Screw mounting

PSE is fast and easy to install by using screw mounting.



Digital input for start, stop and reset

PSE is controlled through digital inputs using the internal 24 V DC source. This allows easy control with e.g. pushbuttons or relays.

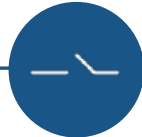

Output signal relays for run, top of ramp and event

Three output signal relays for indicating that the motor is running, that the softstarter is in top of ramp and if any event has happened. The relays can be used e.g. with pilot lights or to control a line contactor.



Clear markings on the front for easy installation

All markings are on the front, making it very easy to read after installation.

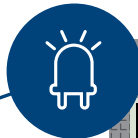

LED indicators

- Green ready LED
Flashing - Supply available
Steady - Main available
- Green run LED
Flashing - Ramping up/down
Steady - TOR
- Yellow protection LED
- Red fault LED

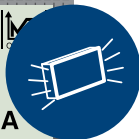
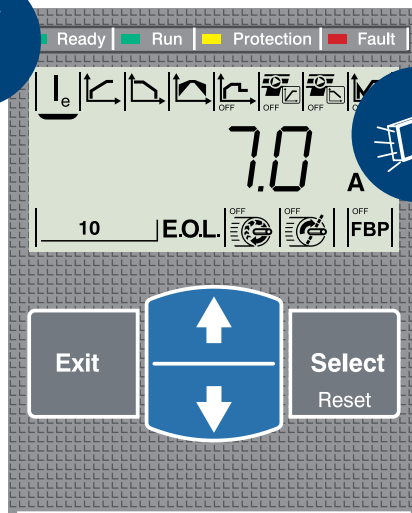

Illuminated and language-neutral display with icons

The display on PSE uses icons for fast and easy set-up of parameters. Each icon indicates a different parameter to set and makes navigation and setting of parameters easy. Set-up is done by using the four buttons on the keypad.

PSE – The efficient range

Overview

3



Normal start In-line connected	PSE18	PSE25	PSE30	PSE37	PSE45	PSE60	PSE72	PSE85	PSE105
(400 V) kW	7.5	11	15	18.5	22	30	37	45	55
IEC, max. A	18	25	30	37	45	60	72	85	106
(440-480 V) hp	10	15	20	25	30	40	50	60	75
UL, max. FLA	18	25	28	34	42	60	68	80	104
UL coordination	600 V, 40 °C								
J-type fuses for UL coordination ¹⁾	Max fuse J-type (85 kA)								
	J-40	J-50	J-60	J-80	J-100	J-125	J-150	J-175	J-225
	UL circuit breaker 480VAC (65 kA)								
UL listed circuit breaker ¹⁾	T4H250								
IEC coordination	400 V, 40 °C								
	MCCB (35 kA)								
Using MCCB only, Type 1 coordination will be achieved. ¹⁾	XT2N160								
	MCCB (50 kA)								
	XT2S160								
To achieve Type 2 coordination, semiconductor fuses must be used. ¹⁾	Fuse protection (85 kA), Semiconductor fuses, Bussmann								
	170M1563	170M1564	170M1566	170M1567	170M1568	170M1569	170M1571	170M1572	170M3819
Suitable switch fuse for recommended semiconductor fuses. ¹⁾	Switch fuse								
	OS32GD			OS63GD			OS125GD		OS250D
The line contactor is not required for the softstarter itself but often used to open if OL trips. ¹⁾	Line contactor								
	AF26		AF30	AF38	AF52	AF65	AF80	AF96	AF116

¹⁾ This is an example of coordination. For more examples see: applications.it.abb.com/SOC.

PSE – The efficient range

Overview



Normal start In-line connected	PSE142	PSE170	PSE210	PSE250	PSE300	PSE370
(400 V) kW	75	90	110	132	160	200
IEC, max. A	143	171	210	250	300	370
(440-480 V) hp	100	125	150	200	250	300
UL, max. FLA	130	169	192	248	302	361
UL coordination	600 V, 40 °C					
J-type fuses for UL coordination ¹⁾	Max fuse J-type (85 kA)					
	J-300	J-350	J-450	J-500		J-600
	UL circuit breaker 480VAC (65 kA)					
UL listed circuit breaker ¹⁾	T5L400			T5H600		
IEC coordination	400 V, 40 °C					
	MCCB (35 kA)					
Using MCCB only, Type 1 coordination will be achieved. ¹⁾	XT2N160		T4N320	T5N400		T5N630
	MCCB (50 kA)					
	XT2S160	XT4S250	T4S320	T5S400		T5S630
To achieve Type 2 coordination, semiconductor fuses must be used. ¹⁾	Fuse protection (85kA), Semiconductor fuses, Bussmann					
	170M5809	170M5810	170M5812	170M5813	170M6812	170M6813
Suitable switch fuse for recommended semiconductor fuses. ¹⁾	Switch fuse					
	OS400D				OS630D	
The line contactor is not required for the softstarter itself but often used to open if OL trips ¹⁾	Line contactor					
	AF140	AF190	AF205	AF265	AF305	AF370

¹⁾ This is an example of coordination. For more examples see: applications.it.abb.com/SOC.

PSE – The efficient range

Normal starts, class 10, in-line, ordering details



3



PSE18 ... PSE105

Description

Selection table for normal start.

Typical applications:

- Bow thruster
- Centrifugal pump
- Compressor
- Conveyor or belt (short)
- Elevator
- Escalator



If more than 10 starts/h, select one size larger than the standard selection.

For a more precise selection, use the online softstarter selection tool available by scanning the shown QR code or using the selection tool available at:

new.abb.com/low-voltage/products/softstarters



PSE142 ... PSE170



PSE210 ... PSE370

Rated operational voltage U_e , 208...600 V

Rated control supply voltage U_s , 100...250 V AC, 50/60 Hz

IEC				UL/CSA					Catalog number	Global reference code	Weight (1 pce)			
Rated operational power			current	Rated operational power				current					kg	(lb)
230 V	400 V	500 V		200 / 208 V	220 / 240 V	440 / 480 V	550 / 600 V							
P_e	P_e	P_e	I_e	P_e	P_e	P_e	P_e	A						
kW	kW	kW	A	hp	hp	hp	hp	A						
4	7.5	11	18	5	5	10	15	18	PSE18-600-70	1SFA897101R7000	2.40	(5.29)		
5.5	11	15	25	7.5	7.5	15	20	25	PSE25-600-70	1SFA897102R7000	2.40	(5.29)		
7.5	15	18.5	30	7.5	10	20	25	28	PSE30-600-70	1SFA897103R7000	2.40	(5.29)		
9	18.5	22	37	10	10	25	30	34	PSE37-600-70	1SFA897104R7000	2.40	(5.29)		
11	22	30	45	10	15	30	40	42	PSE45-600-70	1SFA897105R7000	2.40	(5.29)		
15	30	37	60	20	20	40	50	60	PSE60-600-70	1SFA897106R7000	2.40	(5.29)		
18.5	37	45	72	20	25	50	60	68	PSE72-600-70	1SFA897107R7000	2.50	(5.51)		
22	45	55	85	25	30	60	75	80	PSE85-600-70	1SFA897108R7000	2.50	(5.51)		
30	55	75	106	30	40	75	100	104	PSE105-600-70	1SFA897109R7000	2.50	(5.51)		
40	75	90	143	40	50	100	125	130	PSE142-600-70	1SFA897110R7000	4.20	(9.26)		
45	90	110	171	60	60	125	150	169	PSE170-600-70	1SFA897111R7000	4.20	(9.26)		
59	110	132	210	60	75	150	200	192	PSE210-600-70	1SFA897112R7000	12.40	(27.34)		
75	132	160	250	75	100	200	250	248	PSE250-600-70	1SFA897113R7000	13.90	(30.64)		
90	160	200	300	100	100	250	300	302	PSE300-600-70	1SFA897114R7000	13.90	(30.64)		
110	200	250	370	125	150	300	350	361	PSE370-600-70	1SFA897115R7000	13.90	(30.64)		

PSE – The efficient range

Heavy-duty starts, class 30, in-line, ordering details



PSE18 ... PSE105



PSE142 ... PSE170



PSE210 ... PSE370

Description

Selection table for heavy-duty start.

Typical applications:

- Centrifugal fan
- Conveyor belt (long)
- Crusher
- Mill
- Mixer
- Stirrer

If more than 10 starts/h, select one size larger than the standard selection.

For a more precise selection, use the online softstarter selection tool available by scanning the shown QR code or using the selection tool available at:

new.abb.com/low-voltage/products/softstarters



Rated operational voltage U_e , 208...600 V									Catalog number	Global reference code	Weight (1 pce)	
Rated control supply voltage U_s , 100...250 V AC, 50/60 Hz												
IEC				UL/CSA					FLA			
Rated operational power			current	Rated operational power				current				
230 V	400 V	500 V		200 / 208 V	220 / 240 V	440 / 480 V	550 / 600 V					
P_e	P_e	P_e	I_e	P_e	P_e	P_e	P_e					
kW	kW	kW	A	hp	hp	hp	hp	A			kg	(lb)
3	5.5	7.5	12	3	3	7.5	10	11	PSE18-600-70	1SFA897101R7000	2.40	(5.29)
4	7.5	11	18	5	5	10	15	18	PSE25-600-70	1SFA897102R7000	2.40	(5.29)
5.5	11	15	25	7.5	7.5	15	20	25	PSE30-600-70	1SFA897103R7000	2.40	(5.29)
7.5	15	18.5	30	7.5	10	20	25	28	PSE37-600-70	1SFA897104R7000	2.40	(5.29)
9	18.5	22	37	10	10	25	30	34	PSE45-600-70	1SFA897105R7000	2.40	(5.29)
11	22	30	45	10	15	30	40	42	PSE60-600-70	1SFA897106R7000	2.40	(5.29)
15	30	37	60	20	20	40	50	60	PSE72-600-70	1SFA897107R7000	2.50	(5.51)
18.5	37	45	72	20	25	50	60	68	PSE85-600-70	1SFA897108R7000	2.50	(5.51)
22	45	55	85	25	30	60	75	80	PSE105-600-70	1SFA897109R7000	2.50	(5.51)
30	55	75	106	30	40	75	100	104	PSE142-600-70	1SFA897110R7000	4.20	(9.26)
40	75	90	143	40	50	100	125	130	PSE170-600-70	1SFA897111R7000	4.20	(9.26)
45	90	110	171	60	60	125	150	169	PSE210-600-70	1SFA897112R7000	12.40	(27.34)
59	110	132	210	60	75	150	200	192	PSE250-600-70	1SFA897113R7000	13.90	(30.64)
75	132	160	250	75	100	200	250	248	PSE300-600-70	1SFA897114R7000	13.90	(30.64)
90	160	200	300	100	100	250	300	302	PSE370-600-70	1SFA897115R7000	13.90	(30.64)

PSE – The efficient range

Accessories

3



1SFT196099-035C2



SB805-4C2

LZ...



1SFT196099-011C1

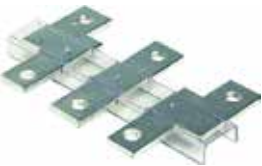

LW...

1SFT196000-011C3



LT ... -AC

1SFT196099-018C3



LT ... -AL

1SFT196099-125



PSEEK

1SFC132238F002



PSECA

1SFC132355F002



PS-FBPA

1SFC132168F001

For softstarter type	Wire range mm ²	Tightening torque max. Nm	Catalog number	Global reference code	Pkg qty	Weight (1 pce) kg (lb)
Terminal lug kits for Al and Cu cables						
PSE142...PSE170	#6 - 300 MCM (1 per phase)	13.5 (275 lb-in)	PSLK-185		6	.79 (1.75)
PSE210...PSE370	#4 - 400 MCM (1 per phase)	43 (375 lb-in)	PSLK-300		6	.74 (1.63)
For softstarter type	Wire range mm ²	Tightening torque max. Nm	Catalog number	Global reference code	Pkg qty	Weight (1 pce) kg (lb)
Cable connectors for Al and Cu cables						
PSE142...PSE170	95...185	31	-	1SDA054988R1	3	0.078 (0.172)
PSE210...PSE370	185...240	43	-	1SDA055020R1	3	0.133 (0.293)
For softstarter type	Dimensions hole ø mm ²	bar mm ²	Catalog number	Global reference code	Pkg qty	Weight (1 pce) kg (lb)
Terminal enlargements						
PSE18...PSE105	6.5	15 x 3	LW110	1SFN074307R1000	1	0.100 (0.220)
PSE142...PSE170	10.5	17.5 x 5	LW185	1SFN074707R1000	1	0.450 (0.992)
PSE210...PSE370	10.5	20 x 5	LW300	1SFN075107R1000	1	1.230 (2.712)
For softstarter type		Req. qty	Catalog number	Global reference code	Pkg qty	Weight (1 pce) kg (lb)
Terminal shrouds						
PSE142...PSE170, short for use with cable clamps		2	LT185-AC	1SFN124701R1000	2	0.050 (0.110)
PSE142...PSE170, long for use with compression lugs		2	LT185-AL	1SFN124703R1000	2	0.220 (0.485)
PSE210...PSE370, short for use with cable clamps		2	LT300-AC	1SFN125101R1000	2	0.070 (0.154)
PSE210...PSE370, long for use with compression lugs		2	LT300-AL	1SFN125103R1000	2	0.280 (0.617)
For softstarter type			Catalog number	Global reference code	Pkg qty	Weight (1 pce) kg (lb)
External keypad including a 3m cable						
PSE18...PSE370			PSEEK	1SFA897100R1001	1	0.198 (0.437)
For softstarter type			Catalog number	Global reference code	Pkg qty	Weight (1 pce) kg (lb)
USB cable for Service Engineer Tool						
PSE18...PSE370			PSECA	1SFA897201R1001	1	0.130 (0.287)
For softstarter type			Catalog number	Global reference code	Pkg qty	Weight (1 pce) kg (lb)
FieldBusPlug connection accessory						
PSE18...PSE370			PS-FBPA	1SFA896312R1002	1	0.060 (0.132)

PSE – The efficient range

Technical data

Tripping curves for the integrated electronic overload protection

PSE has an integrated electronic overload protection that can be set to four different tripping classes. Below find a curve for each tripping class in cold state.

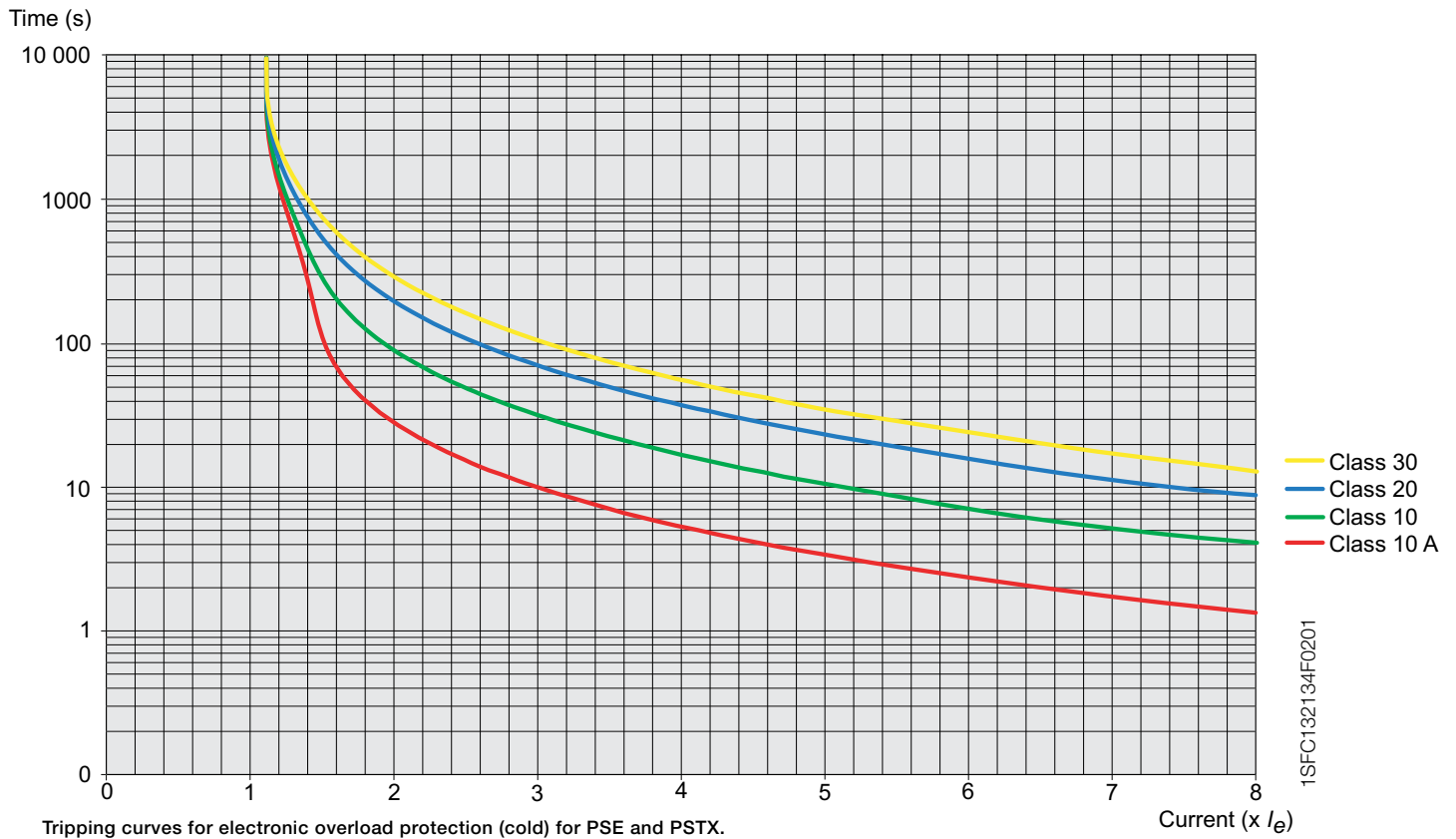

PSE – The efficient range

Technical data

3

Softstarter type		PSE18 ... PSE370
Rated insulation voltage U_i		600 V
Rated operational voltage U_o		208...600 V +10%/-15%
Rated control supply voltage U_s		100...250 V +10%/-15%, 50/60 Hz \pm 5 %
Rated control circuit voltage U_c		Internal 24 V DC
Starting capacity at I_o		4 x I_o for 10 sec.
Number of starts per hour		10 ¹⁾
Overload capability	Overload class	10
Ambient temperature	During operation	-25...+60 °C (-13...+140 F) ²⁾
	During storage	-40...+70 °C (-40...+158 F)
Maximum altitude		4000 m (13123 ft) ³⁾
Degree of protection	Main circuit	IP00
	Supply and control circuit	IP20
Main circuit	Built-in bypass	Yes
	Cooling system — fan cooled (thermostat controlled)	Yes
HMI for settings	Display	4 7-segments and icons. Illuminated
	Keypad	2 selection keys and 2 navigation keys
Main settings	Setting current	Size dependent
	Ramp time during start	1...30 sec
	Ramp time during stop	0...30 sec
	Initial/end voltage	30...70%
	Current limit	1.5...7 x I_o
	Torque control for start	Yes / No
	Torque control for stop	Yes / No
Signal relays	Kick start	Off, 30...100%
	Number of signal relays	3
	K2	Run signal
	K3	TOR (bypass) signal
	K1	Event signal
	Rated operational voltage U_o	250 V AC/24 V DC ⁴⁾
	Rated thermal current I_{th}	3 A
Analog output	Rated operational current I_o at AC-15 ($U_o = 250$ V)	1.5 A
	Output signal reference	4...20 mA
	Type of output signal	I Amp
	Scaling	Fixed at 1.2 x I_o
Control circuit	Number of inputs	3 (start, stop, reset of faults)
Signal indication LED	On / Ready	Green flashing / steady
	Run / TOR	Green flashing / steady
	Protection	Yellow
	Fault	Red
Protections	Electronic overload	Yes (Class 10A, 10, 20, 30)
	Locked rotor protection	Yes
	Underload protection	Yes
Fieldbus connection	Connection for ABB FieldBusPlug	Yes (option)
External keypad	Display	LCD type
	Ambient temperature	
	During operation	-25...+60 °C (-13...+140 F)
	During storage	-40...+70 °C (-40...+158 F)
	Degree of protection	IP66

¹⁾ Valid for 50% on time and 50% off time. If other data is required, contact your local ABB office.

²⁾ Above 40 °C (104 °F) up to max. 60 °C (140 °F) reduce the rated current with 0.6% per °C (0.33% per °F).

³⁾ When used at high altitudes, above 1000 meters (3281 ft) up to 4000 meters (13123 ft), de-rate the rated current using the following formula. [% of $I_e = 100 - \frac{x - 1000}{150} \times x$ = actual altitude of the softstarter in meters. [% of $I_e = 100 - \frac{y - 3280}{480} \times y$ = actual altitude of the softstarter in feet.

For derating of voltage, contact your local ABB office.

⁴⁾ A common voltage needs to be used for all 3 signal relays.

PSE – The efficient range

Technical data

Main terminals			PSE18 ... PSE105	PSE142 ... PSE170	PSE210 ... PSE370
					
	Cu cable - Flexible	1 x mm ²	2.5...70 mm ²	6...120 mm ²	16...300 mm ²
	Clamp type		Included	1SDA066917R1	1SDA055016R1
	Tightening torque		8 Nm	14 Nm	25 Nm
	Cu cable - Flexible	2 x mm ²	2.5...70 mm ²	50...120 mm ²	-
	Clamp type		Included	1SFN074709R1000	-
	Tightening torque		8 Nm	16 Nm	-
	Cu cable - Stranded	1 x mm ²	2.5...70 mm ²	6...120 mm ²	16...300 mm ²
	Clamp type		Included	1SDA066917R1	1SDA055016R1
	Tightening torque		8 Nm	14 Nm	25 Nm
	Cu cable - Stranded	2 x mm ²	2.5...70 mm ²	50...120 mm ²	-
	Clamp type		Included	1SFN074709R1000	-
	Tightening torque		8 Nm	16 Nm	-
	Al cable - Stranded	1 x mm ²	-	95...185 mm ²	185...240
	Clamp type		-	1SDA054988R1	1SDA055020R1
	Tightening torque		-	31 Nm	43 Nm
	Lugs	Width	22 mm (0.866 in)	24 mm (0.945 in)	30 mm (1.181 in)
		Diameter >=	6.5 mm (0.256 in)	8.5 mm (0.335 in)	10.2 mm (0.402 in)
	Tightening torque		9 Nm (80 in lb)	18 Nm (159 in lb)	28 Nm (248 in lb)
	Connection capacity acc to UL / CSA 1 x AWG / kcmil		6...2/0	6...300 kcmil	4...400 kcmil
	Clamp type		Included	ATK185	ATK300
	Tightening torque		71 in lb	300 in lb	375 in lb
	Connection capacity acc to UL / CSA 2 x AWG / kcmil		-	-	4...500 kcmil
	Clamp type		-	-	ATK300/2
	Tightening torque		-	-	375 in lb
	Supply and control circuit	Cu cable - Stranded 1 x mm ²		0.75...2.5 mm ² (19...14 AWG)	
		Cu cable - Stranded 2 x mm ²		0.75...1.5 mm ² (19...16 AWG)	
		Tightening torque		0.5 Nm (4.4 in lb)	

Fuse ratings and power losses

For softstarter	Current range	Max power loss at rated I _e	Max fuse rating - main circuit ¹⁾			Power requirements supply circuit Holding (VA) / Pull-in (VA)
			Bussmann fuses, DIN43 620 (Knife)			
Type	A	W	A	Type	Size	
PSE18	5.4...18.0	0.2	40	170M1563	000	16/19.9
PSE25	7.5...25.0	0.4	50	170M1564	000	16/19.9
PSE30	9.0...30.0	0.5	80	170M1566	000	16/19.9
PSE37	11.1...37.0	0.8	100	170M1567	000	16/19.9
PSE45	13.5...45.0	1.2	125	170M1568	000	16/19.9
PSE60	18.0...60.0	2.2	160	170M1569	000	16/19.9
PSE72	21.6...72.0	3.1	250	170M1571	000	16/19.9
PSE85	25.5...85.0	4.3	315	170M1572	000	16/19.9
PSE105	31.8...106.0	6.6	400	170M3819	1*	16/19.9
PSE142	42.9...143.0	12.1	450	170M5809	2	16/31
PSE170	51.3...171.0	17.6	500	170M5810	2	16/31
PSE210	63.0...210.0	8.8	630	170M5812	2	30/700
PSE250	75.0...250.0	12.5	700	170M5813	2	30/700
PSE300	90.6...302.0	18.0	800	170M6812	3	30/700
PSE370	111.0...370.0	27.4	900	170M6813	3	30/700

¹⁾ For the supply circuit 6 A delayed, for MCB use C characteristics.

PSE – The efficient range

Dimensions

PSE18...PSE105

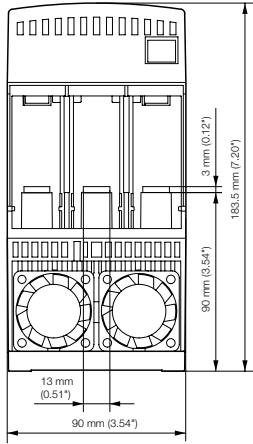

PSE142...PSE170

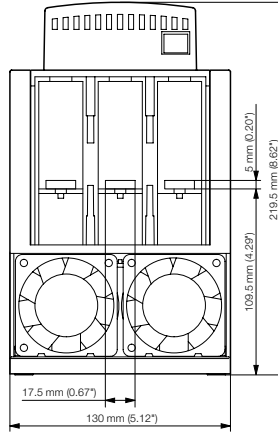

PSE210...PSE370

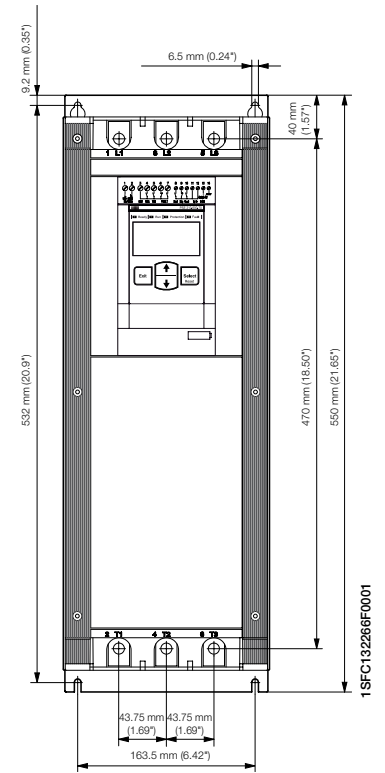
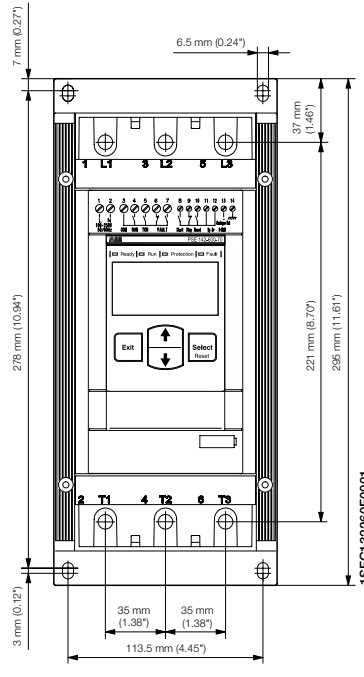
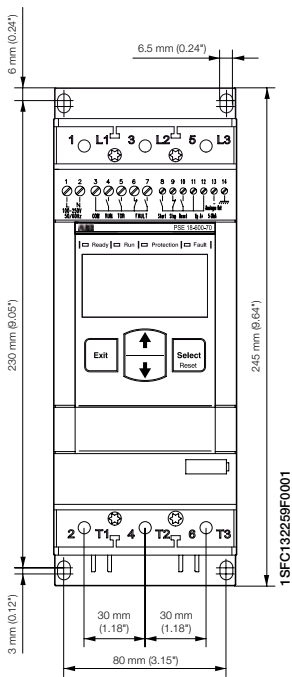
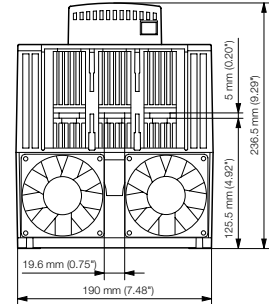

PSE external keypad (PSEEK)

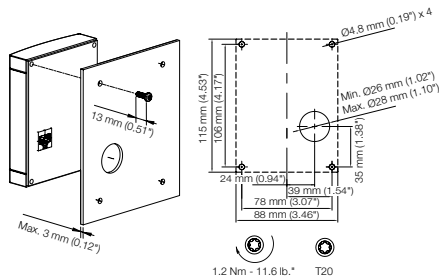
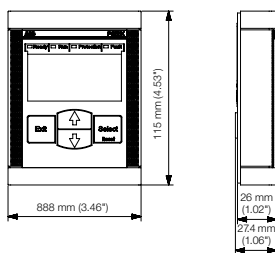

PSE – The efficient range

Circuit diagrams

PSE18...PSE370 With MCCB and line contactor

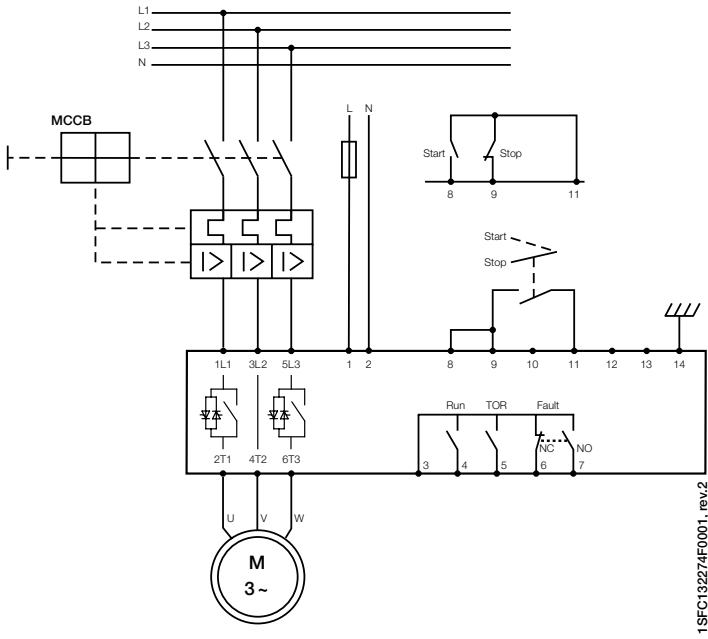

With fuses and line contactor

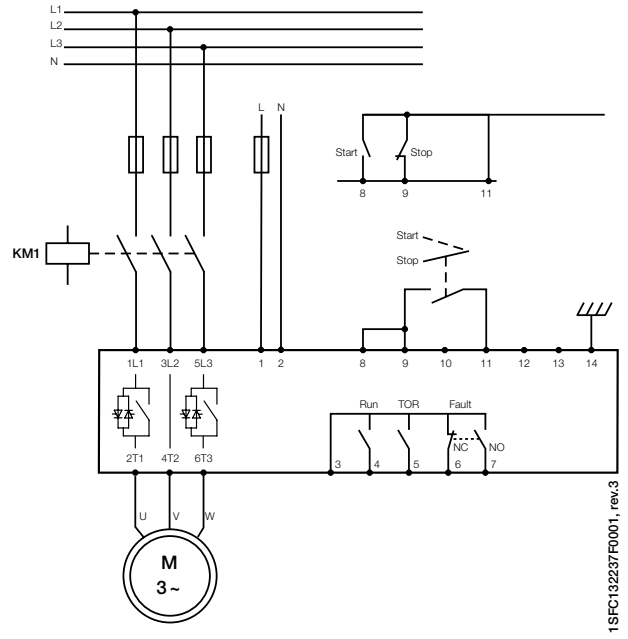



PSTX – The advanced range

PSTX - The advanced range

Introduction	4/2
Overview	4/4
Ordering details	4/6
Accessories	4/10
Technical data	4/11
Dimensions	4/16
Circuit diagrams	4/18

PSTX – The advanced range

Introduction

4



The PSTX combines many years of research and product development with extensive knowledge of application-specific requirements and needs. It is our latest advancement in motor control and protection and adds new functionality and increased reliability.

- Three-phase controlled
- Operational voltage: 208...690 V AC
- Wide rated control supply voltage: 100...250 V, 50/60 Hz
- PSTX rated operational current: 30...1250 A (inside-delta: 2160 A)
- Both in-line and inside-delta connection
- Coated circuit boards protecting from dust, moisture and corrosive atmosphere
- Detachable keypad rated IP66 (Type 1, 4X,12)
- Graphical display with 16 languages for easy setup and operation
- Built-in bypass for energy saving and easy installation
- Built-in Modbus RTU for monitoring and control
- Support for all major communication protocols
- Analog output for measurement of current, voltage, power factor etc.

Secure motor Reliability

Complete motor protection

The PSTX offers complete motor protection in only one unit and is able to handle both load and network irregularities. PT-100, earth fault protection and over/under voltage protection along with many other functions keep your motor safer than ever.

Three types of current limit

PSTX offers three types of current limit: standard, dual and ramp. This gives you full control of your motor during start. It also allows you to use your motor in weaker networks.

Improve installation Efficiency

Built-in bypass saves time and energy

When reaching full speed, the PSTX will activate its bypass. This saves energy while reducing the softstarter's heat generation. With the PSTX, the bypass is built-in and verified by ABB, saving you time during installation and providing space in your panel.

Easy-to-use and detachable keypad

A user-friendly and clear display saves you time and resources during both setup and operation. The detachable keypad is standard on all PSTX softstarters.

Increase application Productivity

Complete control of pumps

It's time to use your processes to their full potential. The PSTX features many application enhancing features, including torque control: the most efficient way to start and stop pumps. The pump cleaning feature can reverse pump flow and clean out pipes, securing uptime of your pump system.

Jog with slow speed

The slow speed forward and backward jog feature will give you more flexibility when operating e.g. conveyor belts and cranes. The PSTX provides positioning capabilities, letting you take control of your process.

PSTX – The advanced range

Introduction



Keyhole mounting for quick installation

The PSTX is simple and quick to install using keyhole mounting, saving you valuable time during the installation.

A compact motor starting solution

When your application reaches full speed, a bypass will reduce the softstarter's energy consumption. It also reduces heat generation, which means you can save money by reducing the need for added cooling equipment. With the PSTX, the bypass is built-in and verified by ABB.

Clear markings on the front

With the PSTX, you do not need a manual to handle control circuit connections. With the self-explanatory markings on the front you can verify that the connections are done right. And with basic data on the front, identification is simple without having to take the product down.

4



Customizable

The PSTX has 17 pre-installed languages along with options to customize your own specific home screens (up to seven unique screens). You can use your customized home screens to show status information important to your process – and hide information that is not.

Easy to learn

A large graphical display along with built-in assistants make learning how to handle the PSTX fun and simple. The interface resembles other interfaces from ABB that streamline and help with training of field personnel.

Detachable

The PSTX comes with a detachable keypad as standard. It can be placed on your panel door, meaning you do not have to interrupt your process in order to read status information or to change settings.

PSTX – The advanced range

Overview

4



Normal start In-Line connected	PSTX30	PSTX37	PSTX45	PSTX60	PSTX72	PSTX85	PSTX105	PSTX142	PSTX170
(400 V) kW	15	18.5	22	30	37	45	55	75	90
IEC, Max. A	30	37	45	60	72	85	106	143	171
(440-480 V) hp	20	25	30	40	50	60	75	100	125
UL, Max. A	28	34	42	60	68	80	104	130	169

UL coordination	600 V, 40 °C								
J-type fuses for UL coordination ¹⁾	Max fuse J-type (100 kA)								
	J-60	J-70	J-90	J-125	J-150	J-175	J-225	J-250	J-250

UL listed circuit breaker ¹⁾	UL circuit breaker 480VAC (65 kA)								
	T4H100			T4H150			T4H250		

IEC coordination	400 V, 40 °C								
Using manual motor starter or MCCB, Type 1 coordination will be achieved. ¹⁾	MCCB (50 kA)								
	XT2S160							XT4S250	

Using gG fuses, Type 1 coordination will be achieved. To achieve Type 2 coordination, semiconductor fuses must be used. ¹⁾	Fuse protection (80 kA), Semiconductor fuses, Bussmann								
	170M1567	170M1568	170M1569		170M1571	170M1572	170M3819	170M5810	170M5812

Suitable switch fuse for the recommended semiconductor fuses. ¹⁾	Switch fuse								
	OS32GD	OS63GD			OS125GD		OS250D	OS400D	

The line contactor is not required for the softstarter itself but often used to open if OL trips. ¹⁾	Line contactor								
	AF30	AF38	AF52	AF65	AF80	AF96	AF116	AF140	AF190

¹⁾ This is an example of short circuit coordination. For more examples see: applications.it.abb.com/SOC.

PSTX – The advanced range

Overview



Normal start In-Line connected	PSTX210	PSTX250	PSTX300	PSTX370	PSTX470	PSTX570	PSTX720	PSTX840	PSTX1050	PSTX1250
(400 V) kW	110	132	160	200	250	315	400	450	560	710
IEC, Max. A	210	250	300	370	470	570	720	840	1050	1250
(440-480 V) hp	150	200	250	300	400	500	600	700	900	1000
UL, Max. A	192	248	302	361	480	590	720	840	1062	1250
UL coordination	600 V, 40 °C									
J-type fuses for UL coordination ¹⁾	Max fuse J-type (100 kA)									
	J-400	J-500	J-600		L-1200		L-1600		L-2500	
UL listed circuit breaker ¹⁾	UL circuit breaker 480VAC (65 kA)									
	T5H300	T5H400	T5H600		T7H1200		T8VH3000		-	
IEC coordination	400 V, 40 °C									
Using manual motor starter or MCCB, Type 1 coordination will be achieved. ¹⁾	MCCB (50 kA)									
	T4S320	T5S400		T5S630	T7S800		T7S1250		E2.2N 2000	
Using gG fuses, Type 1 coordination will be achieved. To achieve Type 2 coordination, semiconductor fuses must be used. ¹⁾	Fuse protection (80 kA), Semiconductor fuses, Bussmann									
	170M5812	170M5813	170M6812	170M6813	170M6813	170M6814	170M8554	170M6018	170M6020	170M6021
Suitable switch fuse for the recommended semiconductor fuses. ¹⁾	Switch fuse									
	OS400D			OS630D			OS800D		-	
The line contactor is not required for the softstarter itself but often used to open if OL trips. ¹⁾	Line contactor									
	AF205	AF265	AF305	AF370	AF460	AF580	AF750	AF1350	AF1650	-

¹⁾ This is an example of short circuit coordination. For more examples see: applications.it.abb.com/SOC.

PSTX – The advanced range

Normal starts, class 10, in-line, ordering details



PSTX30 ... PSTX105



PSTX142 ... PSTX170



PSTX210 ... PSTX370



PSTX470 ... PSTX570



PSTX720 ... PSTX840



PSTX1050 ... PSTX1250

Description

Selection table for normal start.

Typical applications:

- Bow thruster
- Centrifugal pump
- Compressor
- Conveyor belt (short)
- Elevator



For a more precise selection, use the online softstarter selection tool available by scanning the shown QR code or using the selection tool available at:

new.abb.com/low-voltage/products/softstarters

Rated operational voltage U_e , 208...600 V										Catalog number	Global reference code	Weight (1 pce)	
Rated control supply voltage U_s , 100...250 V AC, 50/60 Hz												kg	(lb)
IEC			UL/CSA										
Rated operational power			current	Rated operational power			current						
400 V	500 V	690 V		200 / 208 V	220 / 240 V	440 / 480 V		550 / 600 V					
P_e kW	P_e kW	P_e kW	I_e A	P_e hp	P_e hp	P_e hp	P_e hp	FLA A					
15	18.5	-	30	7.5	10	20	25	28	PSTX30-600-70	1SFA898103R7000	6.10	(13.45)	
18.5	22	-	37	10	10	25	30	34	PSTX37-600-70	1SFA898104R7000	6.10	(13.45)	
22	25	-	45	10	15	30	40	42	PSTX45-600-70	1SFA898105R7000	6.10	(13.45)	
30	37	-	60	20	20	40	50	60	PSTX60-600-70	1SFA898106R7000	6.10	(13.45)	
37	45	-	72	20	25	50	60	68	PSTX72-600-70	1SFA898107R7000	6.10	(13.45)	
45	55	-	85	25	30	60	75	80	PSTX85-600-70	1SFA898108R7000	6.10	(13.45)	
55	75	-	106	30	40	75	100	104	PSTX105-600-70	1SFA898109R7000	6.10	(13.45)	
75	90	-	143	40	50	100	125	130	PSTX142-600-70	1SFA898110R7000	9.60	(21.16)	
90	110	-	171	50	60	125	150	169	PSTX170-600-70	1SFA898111R7000	9.60	(21.16)	
110	132	-	210	60	75	150	200	192	PSTX210-600-70	1SFA898112R7000	12.70	(27.99)	
132	160	-	250	75	100	200	250	248	PSTX250-600-70	1SFA898113R7000	12.70	(27.99)	
160	200	-	300	100	100	250	300	302	PSTX300-600-70	1SFA898114R7000	12.70	(27.99)	
200	257	-	370	125	150	300	350	361	PSTX370-600-70	1SFA898115R7000	12.70	(27.99)	
250	315	-	470	150	200	400	500	480	PSTX470-600-70	1SFA898116R7000	25.00	(55.12)	
315	400	-	570	200	200	500	600	590	PSTX570-600-70	1SFA898117R7000	25.00	(55.12)	
400	500	-	720	250	300	600	700	720	PSTX720-600-70	1SFA898118R7000	46.20	(101.85)	
450	600	-	840	300	350	700	800	840	PSTX840-600-70	1SFA898119R7000	46.20	(101.85)	
560	730	-	1050	400	450	900	1000	1062	PSTX1050-600-70	1SFA898120R7000	64.20	(141.54)	
710	880	-	1200	400	500	1000	1200	1250	PSTX1250-600-70	1SFC898121R7000	64.70	(142.64)	

Rated operational voltage U_e , 208...690 V										Catalog number	Global reference code	Weight (1 pce)	
Rated control supply voltage U_s , 100...250 V AC, 50/60 Hz												kg	(lb)
IEC			UL/CSA										
Rated operational power			current	Rated operational power			current						
400 V	500 V	690 V		200 / 208 V	220 / 240 V	440 / 480 V		550 / 600 V					
P_e kW	P_e kW	P_e kW	I_e A	P_e hp	P_e hp	P_e hp	P_e hp	FLA A					
15	18.5	25	30	7.5	10	20	25	28	PSTX30-690-70	1SFA898203R7000	6.10	(13.45)	
18.5	22	30	37	10	10	25	30	34	PSTX37-690-70	1SFA898204R7000	6.10	(13.45)	
22	25	37	45	10	15	30	40	42	PSTX45-690-70	1SFA898205R7000	6.10	(13.45)	
30	37	55	60	20	20	40	50	60	PSTX60-690-70	1SFA898206R7000	6.10	(13.45)	
37	45	59	72	20	25	50	60	68	PSTX72-690-70	1SFA898207R7000	6.10	(13.45)	
45	55	75	85	25	30	60	75	80	PSTX85-690-70	1SFA898208R7000	6.10	(13.45)	
55	75	90	106	30	40	75	100	104	PSTX105-690-70	1SFA898209R7000	6.10	(13.45)	
75	90	132	143	40	50	100	125	130	PSTX142-690-70	1SFA898210R7000	9.60	(21.16)	
90	110	160	171	50	60	125	150	169	PSTX170-690-70	1SFA898211R7000	9.60	(21.16)	
110	132	184	210	60	75	150	200	192	PSTX210-690-70	1SFA898212R7000	12.70	(27.99)	
132	160	220	250	75	100	200	250	248	PSTX250-690-70	1SFA898213R7000	12.70	(27.99)	
160	200	257	300	100	100	250	300	302	PSTX300-690-70	1SFA898214R7000	12.70	(27.99)	
200	257	355	370	125	150	300	350	361	PSTX370-690-70	1SFA898215R7000	12.70	(27.99)	
250	315	450	470	150	200	400	500	480	PSTX470-690-70	1SFA898216R7000	25.00	(55.12)	
315	400	560	570	200	200	500	600	590	PSTX570-690-70	1SFA898217R7000	25.00	(55.12)	
400	500	710	720	250	300	600	700	720	PSTX720-690-70	1SFA898218R7000	46.20	(101.85)	
450	600	800	840	300	350	700	800	840	PSTX840-690-70	1SFA898219R7000	46.20	(101.85)	
560	730	1000	1050	400	450	900	1000	1062	PSTX1050-690-70	1SFA898220R7000	64.20	(141.54)	
710	880	1200	1250	400	500	1000	1200	1250	PSTX1250-690-70	1SFA898221R7000	64.70	(142.64)	

PSTX – The advanced range

Heavy-duty, class 30, in-line, ordering details



PSTX30 ... PSTX105



PSTX142 ... PSTX170



PSTX210 ... PSTX370



PSTX470 ... PSTX570



PSTX720 ... PSTX840



PSTX1050 ... PSTX1250

Description

Selection table for heavy-duty start.

Typical applications:

- Centrifugal fan
- Conveyor belt (long)
- Crusher
- Mill
- Mixer
- Stirrer



For a more precise selection, use the online softstarter selection tool available by scanning the shown QR code or using the selection tool available at:

new.abb.com/low-voltage/products/softstarters

Rated operational voltage U_e , 208...600 V

Rated control supply voltage U_s , 100...250 V AC, 50/60 Hz

IEC				UL/CSA					Catalog number	Global reference code	Weight (1 pce)	
Rated operational power			current	Rated operational power				current				
400 V	500 V	690 V		200 / 208 V	220 / 240 V	440 / 480 V	550 / 600 V					
P_e kW	P_e kW	P_e kW	I_e A	P_e hp	P_e hp	P_e hp	P_e hp	FLA A	kg	(lb)		
11	15	-	22	5	7.5	15	20	25	PSTX30-600-70	1SFA898103R7000	6.10	(13.45)
15	18.5	-	30	7.5	10	20	25	28	PSTX37-600-70	1SFA898104R7000	6.10	(13.45)
18.5	22	-	37	10	10	25	30	34	PSTX45-600-70	1SFA898105R7000	6.10	(13.45)
22	25	-	45	10	15	30	40	42	PSTX60-600-70	1SFA898106R7000	6.10	(13.45)
30	37	-	60	20	20	40	50	60	PSTX72-600-70	1SFA898107R7000	6.10	(13.45)
37	45	-	72	20	25	50	60	68	PSTX85-600-70	1SFA898108R7000	6.10	(13.45)
45	55	-	85	25	30	60	75	80	PSTX105-600-70	1SFA898109R7000	6.10	(13.45)
55	75	-	106	30	40	75	100	104	PSTX142-600-70	1SFA898110R7000	9.60	(21.16)
75	90	-	143	40	50	100	125	130	PSTX170-600-70	1SFA898111R7000	9.60	(21.16)
90	110	-	171	50	60	125	150	169	PSTX210-600-70	1SFA898112R7000	12.70	(27.99)
110	132	-	210	60	75	150	200	192	PSTX250-600-70	1SFA898113R7000	12.70	(27.99)
132	160	-	250	75	100	200	250	248	PSTX300-600-70	1SFA898114R7000	12.70	(27.99)
160	200	-	300	100	100	250	300	302	PSTX370-600-70	1SFA898115R7000	12.70	(27.99)
200	257	-	370	125	150	300	350	361	PSTX470-600-70	1SFA898116R7000	25.00	(55.12)
250	315	-	470	150	200	400	500	480	PSTX570-600-70	1SFA898117R7000	25.00	(55.12)
315	400	-	570	200	200	500	600	590	PSTX720-600-70	1SFA898118R7000	46.20	(101.85)
400	500	-	720	250	300	600	700	720	PSTX840-600-70	1SFA898119R7000	46.20	(101.85)
450	600	-	840	300	350	700	800	840	PSTX1050-600-70	1SFA898120R7000	64.20	(141.54)
560	730	-	1050	400	450	900	1000	1062	PSTX1250-600-70	1SFA898121R7000	64.70	(142.64)

Rated operational voltage U_e , 208...690 V

Rated control supply voltage U_s , 100...250 V AC, 50/60 Hz

11	15	18.5	22	5	7.5	15	20	25	PSTX30-690-70	1SFA898203R7000	6.10	(13.45)
15	18.5	25	30	7.5	10	20	25	28	PSTX37-690-70	1SFA898204R7000	6.10	(13.45)
18.5	22	30	37	10	10	25	30	34	PSTX45-690-70	1SFA898205R7000	6.10	(13.45)
22	25	37	44	10	15	30	40	42	PSTX60-690-70	1SFA898206R7000	6.10	(13.45)
30	37	55	60	20	20	40	50	60	PSTX72-690-70	1SFA898207R7000	6.10	(13.45)
37	45	59	72	20	25	50	60	68	PSTX85-690-70	1SFA898208R7000	6.10	(13.45)
45	55	75	85	25	30	60	75	80	PSTX105-690-70	1SFA898209R7000	6.10	(13.45)
55	75	90	106	30	40	75	100	104	PSTX142-690-70	1SFA898210R7000	9.60	(21.16)
75	90	132	143	40	50	100	125	130	PSTX170-690-70	1SFA898211R7000	9.60	(21.16)
90	110	160	171	50	60	125	150	169	PSTX210-690-70	1SFA898212R7000	12.70	(27.99)
110	132	184	210	60	75	150	200	192	PSTX250-690-70	1SFA898213R7000	12.70	(27.99)
132	160	220	250	75	100	200	250	248	PSTX300-690-70	1SFA898214R7000	12.70	(27.99)
160	200	257	300	100	100	250	300	302	PSTX370-690-70	1SFA898215R7000	12.70	(27.99)
200	257	355	370	125	150	300	350	361	PSTX470-690-70	1SFA898216R7000	25.00	(55.12)
250	315	450	470	150	200	400	500	480	PSTX570-690-70	1SFA898217R7000	25.00	(55.12)
315	400	560	570	200	200	500	600	590	PSTX720-690-70	1SFA898218R7000	46.20	(101.85)
400	500	710	720	250	300	600	700	720	PSTX840-690-70	1SFA898219R7000	46.20	(101.85)
450	600	800	840	300	350	700	800	840	PSTX1050-690-70	1SFA898220R7000	64.20	(141.54)
560	730	1000	1050	400	450	900	1000	1062	PSTX1250-690-70	1SFA898221R7000	64.70	(142.64)

PSTX – The advanced range

Normal starts, class 10, inside delta, ordering details

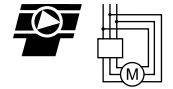

PSTX30 ... PSTX105



PSTX142 ... PSTX170



PSTX210 ... PSTX370



PSTX470 ... PSTX570



PSTX720 ... PSTX840



PSTX1050 ... PSTX1250

Description

Selection table for normal start.

Typical applications:

- Bow thruster
- Centrifugal pump
- Compressor
- Conveyor belt (short)
- Elevator



For a more precise selection, use the online softstarter selection tool available by scanning the shown QR code or using the selection tool available at:

new.abb.com/low-voltage/products/softstarters

Rated operational voltage U_e , 208...600 V

Rated control supply voltage U_s , 100...250 V AC, 50/60 Hz

IEC				UL/CSA					Catalog number	Global reference code	Weight (1 pce)	
Rated operational power			current	Rated operational power				current				
400 V	500 V	690 V		200 / 208 V	220 / 240 V	440 / 480 V	550 / 600 V					
P_e kW	P_e kW	P_e kW	I_e A	P_e hp	P_e hp	P_e hp	P_e hp	FLA A	kg	(lb)		
25	30	-	52	10	15	30	40	48	PSTX30-600-70	1SFA898103R7000	6.10	(13.45)
30	37	-	64	15	20	40	50	58	PSTX37-600-70	1SFA898104R7000	6.10	(13.45)
37	45	-	76	20	25	50	60	72	PSTX45-600-70	1SFA898105R7000	6.10	(13.45)
55	75	-	105	30	40	75	100	103	PSTX60-600-70	1SFA898106R7000	6.10	(13.45)
59	80	-	124	30	40	75	100	117	PSTX72-600-70	1SFA898107R7000	6.10	(13.45)
75	90	-	147	40	50	100	125	138	PSTX85-600-70	1SFA898108R7000	6.10	(13.45)
90	110	-	181	60	60	150	150	180	PSTX105-600-70	1SFA898109R7000	6.10	(13.45)
132	160	-	245	75	75	150	200	225	PSTX142-600-70	1SFA898110R7000	9.60	(21.16)
160	200	-	300	75	100	200	250	292	PSTX170-600-70	1SFA898111R7000	9.60	(21.16)
184	250	-	360	100	125	250	300	332	PSTX210-600-70	1SFA898112R7000	12.70	(27.99)
220	295	-	430	150	150	350	450	429	PSTX250-600-70	1SFA898113R7000	12.70	(27.99)
257	355	-	515	150	200	450	500	523	PSTX300-600-70	1SFA898114R7000	12.70	(27.99)
355	450	-	640	200	250	500	600	625	PSTX370-600-70	1SFA898115R7000	12.70	(27.99)
450	600	-	814	250	300	600	700	830	PSTX470-600-70	1SFA898116R7000	25.00	(55.12)
540	700	-	987	300	350	700	800	1020	PSTX570-600-70	1SFA898117R7000	25.00	(55.12)
710	880	-	1247	400	500	1000	1200	1240	PSTX720-600-70	1SFA898118R7000	46.20	(101.85)
800	1000	-	1455	500	600	1200	1500	1450	PSTX840-600-70	1SFA898119R7000	46.20	(101.85)
1000	1250	-	1810	600	700	1500	1800	1830	PSTX1050-600-70	1SFA898120R7000	64.20	(141.54)
1200	1500	-	2160	800	900	1800	2000	2160	PSTX1250-600-70	1SFA898121R1000	64.70	(142.64)

Rated operational voltage U_e , 208...690 V

Rated control supply voltage U_s , 100...250 V AC, 50/60 Hz

25	30	45	52	10	15	30	40	48	PSTX30-690-70	1SFA898203R7000	6.10	(13.45)
30	37	55	64	15	20	40	50	58	PSTX37-690-70	1SFA898204R7000	6.10	(13.45)
37	45	59	76	20	25	50	60	72	PSTX45-690-70	1SFA898205R7000	6.10	(13.45)
55	75	90	105	30	40	75	100	103	PSTX60-690-70	1SFA898206R7000	6.10	(13.45)
59	80	110	124	30	40	75	100	117	PSTX72-690-70	1SFA898207R7000	6.10	(13.45)
75	90	132	147	40	50	100	125	138	PSTX85-690-70	1SFA898208R7000	6.10	(13.45)
90	110	160	181	60	60	150	150	180	PSTX105-690-70	1SFA898209R7000	6.10	(13.45)
132	160	220	245	75	75	150	200	225	PSTX142-690-70	1SFA898210R7000	9.60	(21.16)
160	200	257	300	75	100	200	250	292	PSTX170-690-70	1SFA898211R7000	9.60	(21.16)
184	250	315	360	100	125	250	300	332	PSTX210-690-70	1SFA898212R7000	12.70	(27.99)
220	295	400	430	150	150	350	450	429	PSTX250-690-70	1SFA898213R7000	12.70	(27.99)
257	355	500	515	150	200	450	500	523	PSTX300-690-70	1SFA898214R7000	12.70	(27.99)
355	450	600	640	200	250	500	600	625	PSTX370-690-70	1SFA898215R7000	12.70	(27.99)
450	600	800	814	250	300	600	700	720	PSTX470-690-70	1SFA898216R7000	25.00	(55.12)
540	700	960	987	300	350	700	800	840	PSTX570-690-70	1SFA898217R7000	25.00	(55.12)
710	880	1200	1247	400	500	1000	1200	1247	PSTX720-690-70	1SFA898218R7000	46.20	(101.85)
800	1000	1400	1455	500	600	1200	1500	1454	PSTX840-690-70	1SFA898219R7000	46.20	(101.85)
1000	1250	1700	1810	600	700	1500	1800	1839	PSTX1050-690-70	1SFA898220R7000	64.20	(141.54)
1200	1500	2000	2160	800	900	1800	2000	2160	PSTX1250-690-70	1SFA898221R7000	64.70	(142.64)

PSTX – The advanced range

Heavy-duty, class 30, inside delta, ordering details



PSTX30 ... PSTX105



PSTX142 ... PSTX170



PSTX210 ... PSTX370



PSTX470 ... PSTX570



PSTX720 ... PSTX840



PSTX1050 ... PSTX1250

Description

Selection table for heavy-duty start.

Typical applications:

- Centrifugal fan
- Conveyor belt (long)
- Crusher
- Mill
- Mixer
- Stirrer



For a more precise selection, use the online softstarter selection tool available by scanning the shown QR code or using the selection tool available at:

new.abb.com/low-voltage/products/softstarters

Rated operational voltage U_e , 208...600 V

Rated control supply voltage U_s , 100...250 V AC, 50/60 Hz

IEC				UL/CSA					Catalog number	Global reference code	Weight (1 pce)	
Rated operational power			current	Rated operational power				FLA			kg	(lb)
400 V	500 V	690 V		200 / 208 V	220 / 240 V	440 / 480 V	550 / 600 V					
P_e kW	P_e kW	P_e kW	I_e A	P_e hp	P_e hp	P_e hp	P_e hp	FLA A				
18.5	25	-	42	7.5	10	25	30	34	PSTX30-600-70	1SFA898103R7000	6.10	(13.45)
25	30	-	52	10	15	30	40	48	PSTX37-600-70	1SFA898104R7000	6.10	(13.45)
30	37	-	64	15	20	40	50	58	PSTX45-600-70	1SFA898105R7000	6.10	(13.45)
37	45	-	76	20	25	50	60	72	PSTX60-600-70	1SFA898106R7000	6.10	(13.45)
55	75	-	105	30	40	75	100	103	PSTX72-600-70	1SFA898107R7000	6.10	(13.45)
59	80	-	124	30	40	75	100	117	PSTX85-600-70	1SFA898108R7000	6.10	(13.45)
75	90	-	147	40	50	100	125	138	PSTX105-600-70	1SFA898109R7000	6.10	(13.45)
90	110	-	181	60	60	150	150	180	PSTX142-600-70	1SFA898110R7000	9.60	(21.16)
132	160	-	245	75	75	150	200	225	PSTX170-600-70	1SFA898111R7000	9.60	(21.16)
160	200	-	300	75	100	200	250	292	PSTX210-600-70	1SFA898112R7000	12.70	(27.99)
184	250	-	360	100	125	250	300	332	PSTX250-600-70	1SFA898113R7000	12.70	(27.99)
220	295	-	430	150	150	350	450	429	PSTX300-600-70	1SFA898114R7000	12.70	(27.99)
257	355	-	515	150	200	450	500	523	PSTX370-600-70	1SFA898115R7000	12.70	(27.99)
355	450	-	640	200	250	500	600	625	PSTX470-600-70	1SFA898116R7000	25.00	(55.12)
450	600	-	814	250	300	600	700	720	PSTX570-600-70	1SFA898117R7000	25.00	(55.12)
540	700	-	987	300	350	700	800	840	PSTX720-600-70	1SFA898118R7000	46.20	(101.85)
710	880	-	1247	400	500	1000	1200	1247	PSTX840-600-70	1SFA898119R7000	46.20	(101.85)
800	1000	-	1455	500	600	1200	1500	1454	PSTX1050-600-70	1SFA898120R7000	64.20	(141.54)
1000	1250	-	1810	600	700	1500	1800	1830	PSTX1250-600-70	1SFA898121R7000	64.70	(142.64)

Rated operational voltage U_e , 208...690 V

Rated control supply voltage U_s , 100...250 V AC, 50/60 Hz

IEC				UL/CSA					Catalog number	Global reference code	Weight (1 pce)	
Rated operational power			current	Rated operational power				FLA			kg	(lb)
400 V	500 V	690 V		200 / 208 V	220 / 240 V	440 / 480 V	550 / 600 V					
P_e kW	P_e kW	P_e kW	I_e A	P_e hp	P_e hp	P_e hp	P_e hp	FLA A				
18.5	25	37	42	7.5	10	25	30	34	PSTX30-690-70	1SFA898203R7000	6.10	(13.45)
25	30	45	52	10	15	30	40	48	PSTX37-690-70	1SFA898204R7000	6.10	(13.45)
30	37	55	64	15	20	40	50	58	PSTX45-690-70	1SFA898205R7000	6.10	(13.45)
37	45	59	76	20	25	50	60	72	PSTX60-690-70	1SFA898206R7000	6.10	(13.45)
55	75	90	105	30	40	75	100	103	PSTX72-690-70	1SFA898207R7000	6.10	(13.45)
59	80	110	124	30	40	75	100	117	PSTX85-690-70	1SFA898208R7000	6.10	(13.45)
75	90	132	147	40	50	100	125	138	PSTX105-690-70	1SFA898209R7000	6.10	(13.45)
90	110	160	181	60	60	150	150	180	PSTX142-690-70	1SFA898210R7000	9.60	(21.16)
132	160	220	245	75	75	150	200	225	PSTX170-690-70	1SFA898211R7000	9.60	(21.16)
160	200	257	300	75	100	200	250	292	PSTX210-690-70	1SFA898212R7000	12.70	(27.99)
184	250	315	360	100	125	250	300	332	PSTX250-690-70	1SFA898213R7000	12.70	(27.99)
220	295	400	430	150	150	350	450	429	PSTX300-690-70	1SFA898214R7000	12.70	(27.99)
257	355	500	515	150	200	450	500	523	PSTX370-690-70	1SFA898215R7000	12.70	(27.99)
355	450	600	640	200	250	500	600	625	PSTX470-690-70	1SFA898216R7000	25.00	(55.12)
450	600	800	814	250	300	600	700	720	PSTX570-690-70	1SFA898217R7000	25.00	(55.12)
540	700	960	987	300	350	700	800	840	PSTX720-690-70	1SFA898218R7000	46.20	(101.85)
710	880	1200	1247	400	500	1000	1200	1247	PSTX840-690-70	1SFA898219R7000	46.20	(101.85)
800	1000	1400	1455	500	600	1200	1500	1454	PSTX1050-690-70	1SFA898220R7000	64.20	(141.54)
1000	1250	1700	1810	600	700	1500	1800	1830	PSTX1250-690-70	1SFA898221R7000	64.70	(142.64)

PSTX – The advanced range

Accessories

4



LZ...

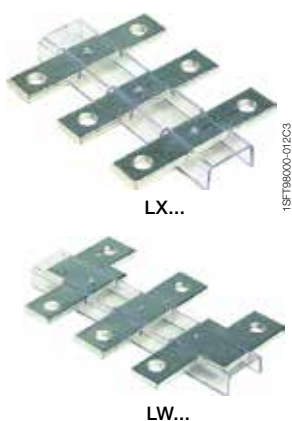

LX...

LW...

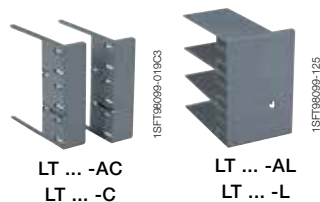

LT ... -AC
LT ... -C

LT ... -AL
LT ... -L

For softstarter type	Wire range mm ²	Tightening torque max. Nm	Catalog number	Global reference code	Pkg qty	Weight (1 pce) kg (lb)
Terminal lug kits for Al and Cu cables						
PSTX142...PSTX170	#6 - 300 MCM (1 per phase)	13.5 (275 lb-in)	PSLK-185		6	.79 (1.75)
PSTX210...PSTX370	#4 - 400 MCM (1 per phase)	43 (375 lb-in)	PSLK-300		6	.74 (1.63)
PSTX210...PSTX370	#4 - 500 MCM (2 per phase)	43 (375 lb-in)	PSLK-300/2		6	1.28 (2.82)
PSTX470...PSTX1050	2/0 - 500 MCM (2 per phase)	43 (375 lb-in)	PSLK580/2		6	1.31 (2.89)
PSTX720...PSTX1050	2/0 - 500 MCM (3 per phase)	43 (375 lb-in)	PSLK750/3		6	2.16 (4.77)
*PSLK contains 2 - ATK kits plus softstarter hardware						
Cable connectors for Al cables						
PSTX142...PSTX170	95...185	31	-	1SDA054988R1	3	0.078 (0.172)
PSTX210...PSTX370	185...240	43	-	1SDA055020R1	3	0.133 (0.293)
PSTX470...PSTX570	2 x (120...240)	31	-	1SDA023380R1	3	0.110 (0.243)
For softstarter type	Dimensions hole ø mm ²	bar mm	Catalog number	Global reference code	Pkg qty	Weight (1 pce) kg (lb)
Terminal extensions						
PSTX142...PSTX170	8.5	17.5 x 5	LX205	1SFN074810R1000	1	0.250 (5.551)
PSTX210...PSTX370	10.5	20 x 5	LX370	1SFN075410R1000	1	0.350 (0.772)
PSTX470...PSTX570	10.5	25 x 5	LX460	1SFN075710R1000	1	0.500 (1.102)
PSTX720...PSTX840	13	40 x 6	LX750	1SFN076110R1003	1	0.850 (1.874)
Terminal enlargements						
PSTX30...PSTX105	6.5	15 x 3	LW110	1SFN074307R1000	1	0.100 (0.220)
PSTX142...PSTX170	10.5	17.5 x 5	LW205	1SFN074807R1000	1	0.250 (5.551)
PSTX210...PSTX370	10.5	20 x 5	LW370	1SFN075407R1000	1	0.450 (0.992)
PSTX470...PSTX570	10.5	25 x 5	LW460	1SFN075707R1000	1	0.730 (1.609)
PSTX720...PSTX840	13	40 x 6	LW750	1SFN076107R1000	1	1.230 (2.712)
For softstarter type		Req. qty	Catalog number	Global reference code	Pkg qty	Weight (1 pce) kg (lb)
Terminal shrouds						
PSTX142...PSTX170, short for use with cable clamps		2	LT205-30C	1SFN124801R1000	2	0.050 (0.110)
PSTX142...PSTX170, long for use with compression lugs		2	LT205-30L	1SFN124803R1000	2	0.220 (0.485)
PSTX210...PSTX370, short for use with cable clamps		2	LT370-30C	1SFN125401R1000	2	0.035 (0.077)
PSTX210...PSTX370, long for use with compression lugs		2	LT370-30L	1SFN125403R1000	2	0.280 (0.617)
PSTX210...PSTX370, long and deep for use with extending cable clamps, ATK300/2 and OZXB4		2	LT370-30D	1SFN125406R1000	2	0.150 (0.331)
PSTX470...PSTX570, short for use with cable clamps		2	LT460-AC	1SFN125701R1000	2	0.100 (0.220)
PSTX470...PSTX570, long for use with compression lugs		2	LT460-AL	1SFN125703R1000	2	0.800 (1.764)
PSTX720...PSTX840, short for use with cable clamps		2	LT750-AC	1SFN126101R1000	2	0.120 (0.265)
PSTX720...PSTX840, long for use with compression lugs		2	LT750-AL	1SFN126103R1000	2	0.825 (1.819)
For softstarter type			Catalog number	Global reference code	Pkg qty	Weight (1 pce) kg (lb)
FieldBusPlug connection accessory						
PSTX30...PSTX1250			PS-FBPA	1SFA896312R1002	1	0.060 (0.132)
I/O module, 24 V DC digital input						
PSTX30...PSTX1250			DX111-FBP.0	1SAJ611000R0101	1	0.220 (0.485)

PSTX – The advanced range

Technical data

Tripping curves for the integrated electronic overload protection

PSTX has an integrated electronic overload protection that can be set to four different tripping classes. Below you find a curve for each tripping class in cold state.

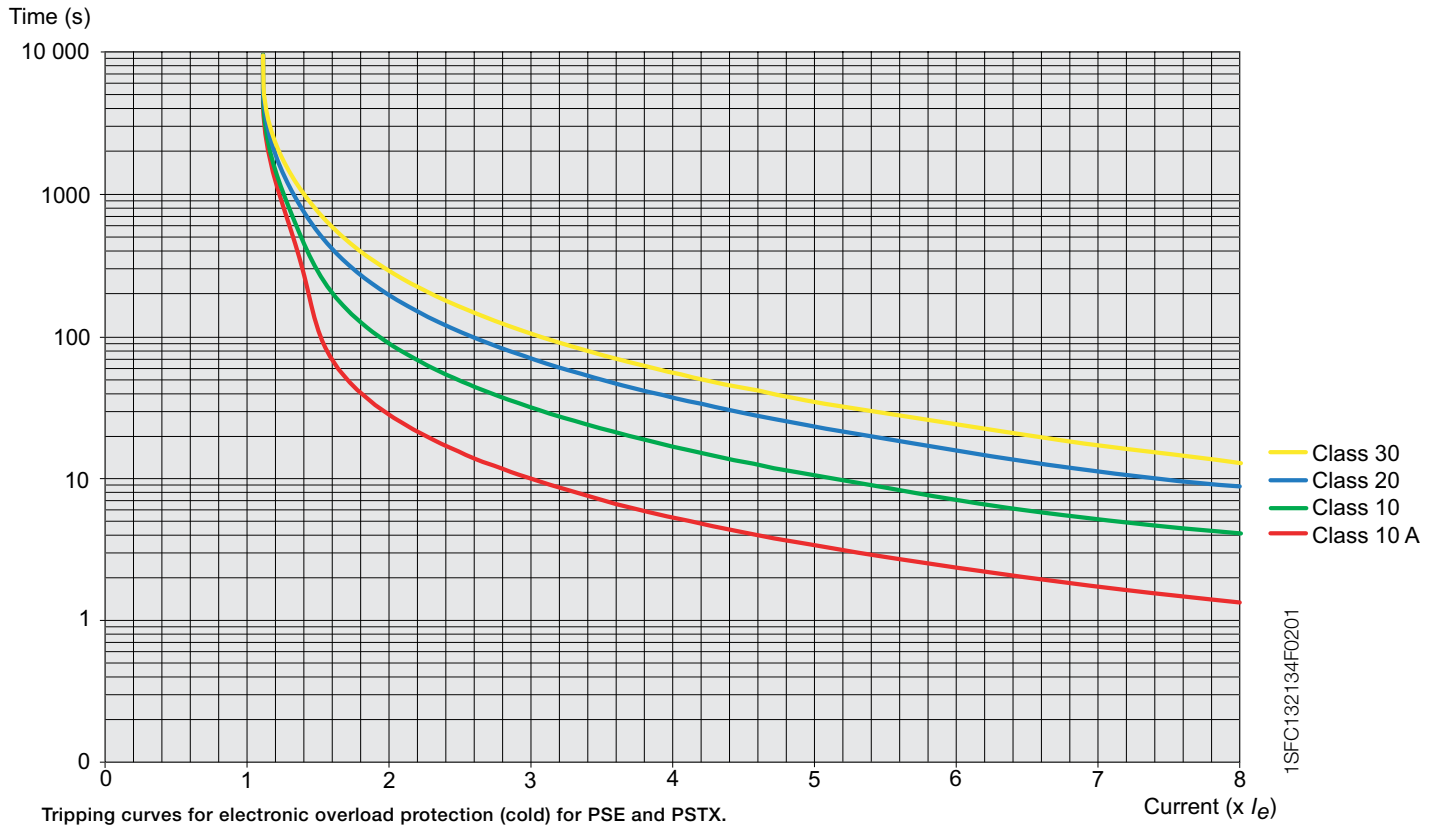

PSTX – The advanced range

Technical data

4

Softstarter type		PSTX30...PSTX1250	
Rated insulation voltage U _i		690V	
Rated operational voltage U _e		208...600 V, 208...690V +10% / -15%, 50/60Hz ±5%	
Rated control supply voltage U _s		100...250 V +10% / -15%, 50/60Hz ±5%	
Rated control circuit voltage U _c		Internal or external 24 V DC	
Starting capacity at I _e		4 x I _e for 10 sec.	
Number of starts per hour		10 for PSTX30...PSTX370 ¹⁾ 6 for PSTX470 ... PSTX1250 ¹⁾	
Overload capability	Overload class	10	
Ambient temperature	During operation	-25...+60 °C, (-13...+140 °F) ²⁾	
	During storage	-40...+70 °C, (-40...+158 °F)	
Maximum altitude		4000 m (13123 ft) ³⁾	
Degree of protection		-	
Main circuit	Supply and control circuit	IP20	
	Built-in bypass contactor	Yes	
	Cooling system - fan cooled	Yes (thermostat controlled)	
HMI for settings (Human Machine Interface)	Display	LCD type, graphical	
	Languages	Arabic, Chinese, Czech, Dutch, English, Finnish, French, German, Greek, Indonesian, Italian, Polish, Portuguese, Russian, Spanish, Swedish and Turkish	
	Keypad	2 selection keys, 4 navigation keys, start key, stop key, info key and remote/local key	
Signal relays	Number of programmable signal relays	3 (each relay can be programmed to None, Run, Top of ramp, Event group 0-6, Sequence 1-3 Run, Sequence 1-3 Top of ramp or Run reverse)	
	K4	Default as Run signal	
	K5	Default as Top of Ramp (Bypass) signal	
	K6	Default as Event group 0 (Faults)	
	Rated operational voltage, U _e	250 V AC/24 V DC	
	Rated thermal current I _{th}	5 A	
Analog output	Rated operational current I _e at AC-15 (U _e =250 V)	1.5 A	
	Output signal reference	0...10 V, 0...10 mA, 0...20 mA, 4...20 mA	
	Type of output signal	Motor current (A), Main voltage (V), Active power (kW), Active power (HP), Reactive power (kVAr), Apparant power (kVArh), Active energy (kWh), Reactive energy (kVArh), cos phi, Motor temperature (%), Thyristor temperature (%), Motor voltage (%), Main frequency (Hz), PT100 temperature (centigrade), PTC resistance (Ohm)	
Control circuit	Number of inputs	2 (start, stop)	
	Number of additional programmable inputs	3 (each input can be programmed to: None, Reset, Enable, Slow speed forward (Jog), Slow speed reverse (Jog), Motor heating, Stand still brake, Start reverse, User defined protection, Emergency mode (active high), Emergency mode (active low), Fieldbus disable control, Start 1, Start 2, Start 3, Switch to remote control or Cancel brake)	
Signalling indication LED	Ready	Green	
	Run	Green	
	Fault	Red	
	Protection	Yellow	
External keypad	Detachable keypad	Yes	
	Display	LCD type, graphical	
	Ambient temperature		
	During operation	-25...+60 °C, (-13...+140 °F)	
	During storage	-40...+70 °C, (-40...+158 °F)	
	Degree of protection	IP66 (Type 1, 4X, 12)	
Start and stop functions	Soft start with voltage ramp	Yes	
	Soft stop with voltage ramp	Yes	
	Soft start with torque control	Yes	
	Soft stop with torque control	Yes	
	Kick start	Yes	
	Full voltage start	Yes	
	Sequence start	Yes, 3 different sets of settings	
	Current limit	Yes	
	Dual current limit	Yes	
	Current limit ramp	Yes	
	Torque limit	Yes	
	Pre-start function	Yes (Motor heating or Stand still brake)	
	Jog with slow speed, forward and reverse	Yes (3 speed levels)	
	Start reverse (external contactors)	Yes	
	Dynamic brake	Yes	
	Fieldbus connection	Built-in Modbus RTU	Yes
		Connection for Anybus	Yes
		Connection for ABB FieldBusPlug	Yes, with adapter

¹⁾ Valid for normal start (class 10) for 50% on time and 50% off time. If other data if required, contact your local ABB office. ²⁾ Above 40 °C (104 °F) up to max. 60 °C (140 °F) reduce the rated current with 0.8% per °C (0.44% per °F). ³⁾ When used at high altitudes, above 1000 meters (3281 ft) up to 4000 meters (13123 ft), derate the rated current using the following formula.

[% of I_e = 100 - $\frac{x-1000}{150}$] x = actual altitudes of the softstarter in meter, [% of I_e = 100 - $\frac{x-3280}{497}$] x = actual altitude of the softstarter in feet. For derating of voltage, contact your local ABB office.

PSTX – The advanced range

Technical data

Softstarter type	PSTX30...PSTX1250
Protections	Electronic overload protection, EOL Yes (Class 10A, 10, 20, 30)
	Dual overload (separate overload for start and run) Yes
	PTC connection Yes
	PT-100 connection Yes
	Locked rotor protection Yes
	Current underload protection Yes
	Current imbalance protection Yes
	Power factor underload protection Yes
	Under voltage protection Yes
	Over voltage protection Yes
	Voltage imbalance protection Yes
	Earth fault protection / ground fault protection Yes
	Phase reversal protection Yes
	24 V output protection Yes
	Frequency range protection Yes
	Bypass open protection Yes
	User defined protection Yes
	Too long current limit protection Yes
	HMI failure protection Yes
	Fieldbus failure protection Yes
	Extension IO failure protection Yes
	Max number of starts/hour Yes
	Too long start time protection Yes
Warnings	Current underload warning Yes
	Current imbalance warning Yes
	Voltage imbalance warning Yes
	Thyristor overload warning (SCR) Yes
	Electronic overload time-to-trip Yes
	Short circuit warning (for Limp mode) Yes
	Over voltage warning Yes
	Under voltage warning Yes
	Power factor underload warning Yes
	Locked rotor warning Yes
	Faulty fan warning Yes
	THD(U) – Total Harmonic Distortion warning Yes
	Motor runtime limit warning Yes
	Phase loss warning (for stand by) Yes
	EOL warning Yes
External faults detection	Phase loss Yes
	Hight current Yes
	Low control supply voltage Yes
	Faulty usage (e.g. using limp mode inside-delta) Yes
	Faulty connection Yes
	Bad network quality Yes
Internal faults detection	Thyristor overload Yes
	Short circuit Yes
	Open circuit thyristor or gate Yes
	Heat sink over temperature Yes
	Shunt fault Yes
PTC input	Switch off resistance 2825 ohm ± 20%
	Switch on resistance 1200 ohm ± 20%
Other functions	Real time clock Yes
	Event log Yes
	Emergency mode Yes
	Automatic restart Yes
	Secure settings Yes
	Keypad password Yes
	Electronic overload time-to-cool Yes
	Thyristor runtime measurement Yes
	Auto phase sequence detection Yes
	Electricity metering Yes
	Motor heating Yes
	Stand still brake Yes
	Voltage sags detection Yes
	Limp mode with two-phase motor control if one set of thyristors is shorted Yes

For all functions and features see installation and commissioning manual, 1SFC132081M0201 available at new.abb.com/low-voltage/products/softstarters.

PSTX – The advanced range

Technical data

Fuse ratings and power losses

For softstarter	Current range	Max power loss at rated I_e	Max fuse rating - main circuit ¹⁾²⁾ Bussmann fuses, DIN43 620 (Knife)			Power requirements supply circuit Holding (VA) / Pull-in (VA)
			A	Type	Size	
Type	A	W	A	Type	Size	
PSTX30	9.0...30.0	0.8	100	170M1567	000	49/51
PSTX37	11.1...37.0	1.2	125	170M1568	000	49/51
PSTX45	13.5...45.0	1.8	160	170M1569	000	49/51
PSTX60	18.0...60.0	3.2	160	170M1569	000	49/51
PSTX72	21.6...72.0	4.7	250	170M1571	000	49/51
PSTX85	22.5...85.0	6.5	315	170M1572	000	49/51
PSTX105	31.8...106.0	10	400	170M3819	1*	49/51
PSTX142	42.9...143.0	18	500	170M5810	2	49/53
PSTX170	51.3...171.0	26	630	170M5812	2	49/53
PSTX210	63.0...210.0	48	630	170M5812	2	56/276
PSTX250	75.0...250.0	68	700	170M5813	2	56/276
PSTX300	90.0...300.0	97	800	170M6812	3	56/276
PSTX370	111.0...370.0	148	900	170M6813	3	56/276
PSTX470	141.0...470.0	99	900	170M6813	3	67/434
PSTX570	171.0...570.0	146	1000	170M6814	3	67/434
PSTX720	216.0...720.0	78	1250	170M8554	3	61/929
PSTX840	252.0...840.0	106	1500	170M6018	3	61/929
PSTX1050 ³⁾	315.0...1050.0	165	1800	170M6020	3	68/929
PSTX1250 ³⁾⁴⁾	375.0...1250.0	234	2000	170M6021	3	68/929

¹⁾For the supply circuit 6 A delayed, for MCB use C characteristics.

²⁾For inside delta connection the fuses shall be placed inside the delta. Contact ABB for more information.

³⁾170M6019 with fuse rating 1600 A should be used for 690 V version.













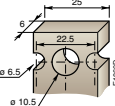
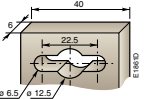
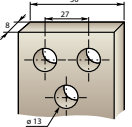



⁴⁾For 690 V version, Bussmann fuses are only available for motors with rated current up to 1150 A.

PSTX Integrated bypass ratings

Softstarter	PSTX470	PSTX570	PSTX720	PSTX840	PSTX1050	PSTX1250
Integrated contactor	AF370			AF750		AF1250
AC-3 rating at 400 V (A)	370			750		-
IEC AC-3 Rated operational power at 400 V (kW)	200			400		-
UL/CSA 3-phase motor rating at 480 V (hp)	300			600		-

PSTX – The advanced range

Technical data

Main terminals			PSTX30...PSTX105	PSTX142...PSTX170	PSTX210...PSTX370	PSTX470...PSTX570	PSTX720...PSTX1050	PSTX1250
								
	Cu cable - flexible	1 x mm ²	10...70 mm ²	6...120 mm ²	16...240 mm ²	-	-	-
			Included	1SDA066917R1	1SDA055016R1	-	-	-
			8 Nm	14 Nm	25 Nm	-	-	-
	Cu cable - flexible	2 x mm ²	6...35 mm ²	50...95 mm ²	70...185 mm ²	-	-	-
	Clamp type		Included	LZ185-2C/120	OZXB4 ¹⁾	-	-	-
			8 Nm	1SFN074709R1000	1SCA022194R0890	-	-	-
			8 Nm	16 Nm	22 Nm	-	-	-
	Cu cable - Stranded	1 x mm ²	10...95 mm ²	6...150 mm ²	16...300 mm ²	-	-	-
			Included	1SDA066917R1	1SDA055016R1	-	-	-
			8 Nm	14 Nm	25 Nm	-	-	-
	Cu cable - Stranded	2 x mm ²	6...35 mm ²	50...120 mm ²	70...185 mm ²	120...240 mm ²	-	-
	Clamp type		Included	LZ185 - 2C/120	OZXB4 ¹⁾	1SDA013922R1	-	-
			8 Nm	1SFN074709R1000	1SCA022194R0890	35 Nm	-	-
			8 Nm	16 Nm	22 Nm	-	-	-
	Cu cable - Stranded	3 x mm ²	-	-	-	-	70...185 mm ²	-
	Clamp type		-	-	-	-	1SDA013956R1	-
	Tightening torque		-	-	-	-	45 Nm	-
	Al cable - Stranded	1 x mm ²	-	95...185 mm ²	185...240 mm ²	-	-	-
			-	1SDA0549881R1	1SDA055020R1	-	-	-
			-	31 Nm	43 Nm	-	-	-
	Al cable - Stranded	2 x mm ²	-	-	-	120...240 mm ²	-	-
	Clamp type		-	-	-	1SDA023380R1	-	-
			-	-	-	31 Nm	-	-
	Lugs	Width ≤	-	24 mm (0.945 in)	32 mm (1.260 in)	47 mm (1.850 in)	50 mm (1.969 in)	50 mm (1.969 in)
			-	8 mm (0.355 in)	10.2 mm (0.402 in)	10.5 mm (0.413 in)	12.5 mm (0.492 in)	13 mm (0.519 in)
			-	18 Nm (160 in lb)	28 Nm (248 in lb)	35 Nm (310 in lb)	45 Nm (398 in lb)	45 Nm (398 in lb)
Connection capacity acc to UL / CSA 1 x AWG / kcmil			6...2/0	6...300 kcmil	4...400 kcmil	-	-	-
			Included	ATK185	ATK300	-	-	-
			71 in lb	300 in lb	375 in lb	-	-	-
Connection capacity acc to UL / CSA 2 x AWG / kcmil			-	-	4...500 kcmil	2/0...500 kcmil	2/0...500 kcmil	-
			-	-	ATK300/2 ²⁾	ATK580/2	ATK580/2	-
			-	-	375 in lb	375 in lb	375 in lb	-
Connection capacity acc to UL / CSA 3 x AWG / kcmil			-	-	-	2/0...500 kcmil	2/0...500 kcmil	-
			-	-	-	ATK750/3	ATK750/3	-
			-	-	-	375 in lb	375 in lb	-
Supply and control circuit								
Cu cable - Stranded 1 x mm ²			0.75...2.5 mm ² (19...14 AWG)					
Cu cable - Stranded 2 x mm ²			0.75...1.5 mm ² (19...16 AWG)					
Tightening torque			0.5 Nm (4.4 in lb)					

¹⁾ Terminal shrouds 1SFN125406R1000 must be used.

²⁾ Terminal shrouds 1SFN125406R1000 can be used.

PSTX - The advanced range

Dimensions

PSTX30...PSTX105

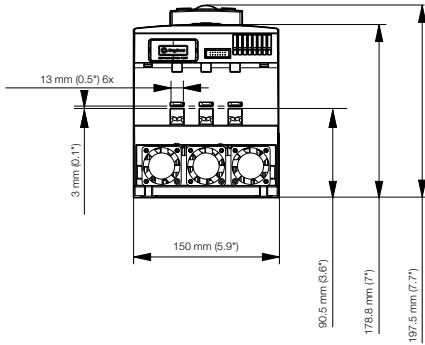

PSTX142...PSTX170

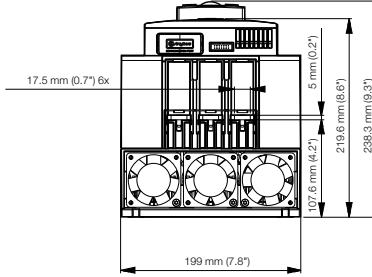

PSTX210...PSTX370

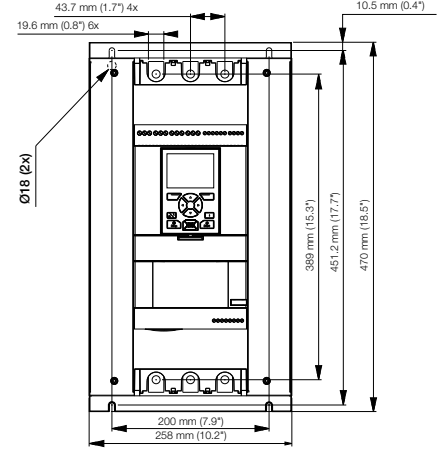
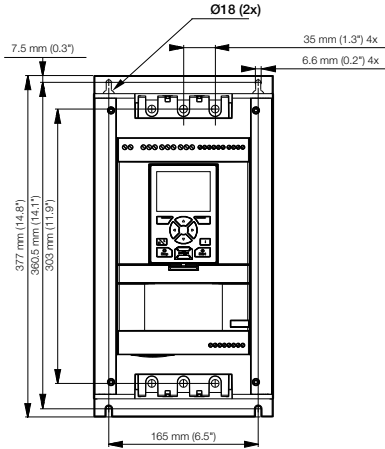
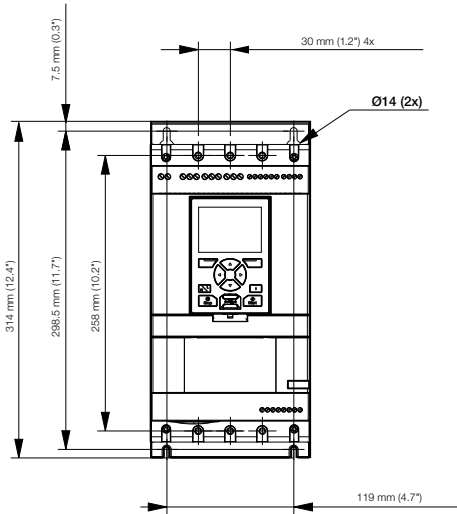
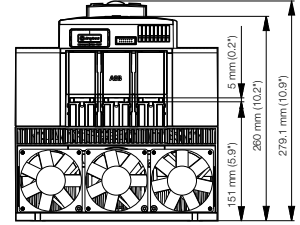

PSTX detachable keypad

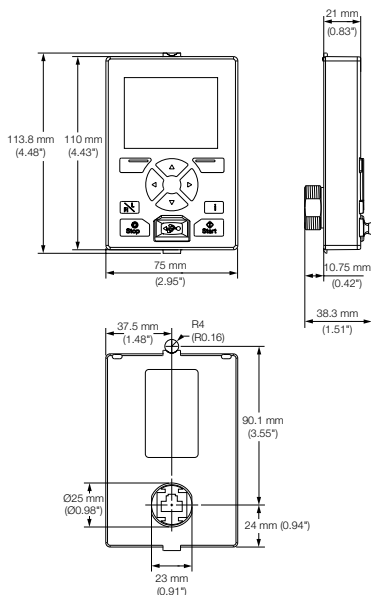

PSTX - The advanced range

Dimensions

PSTX470...PSTX570

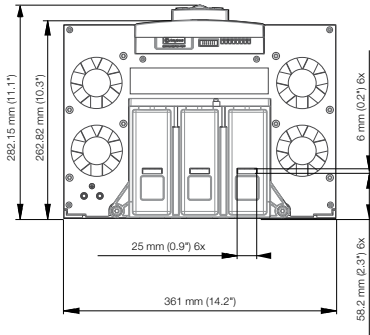

PSTX720...PSTX840

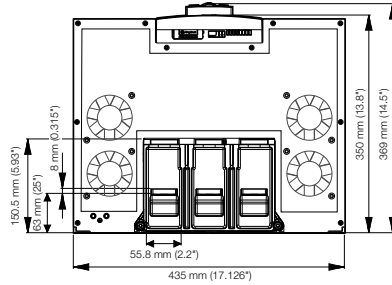

PSTX1050

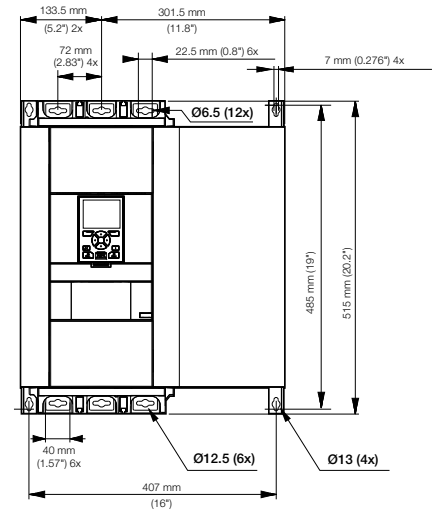
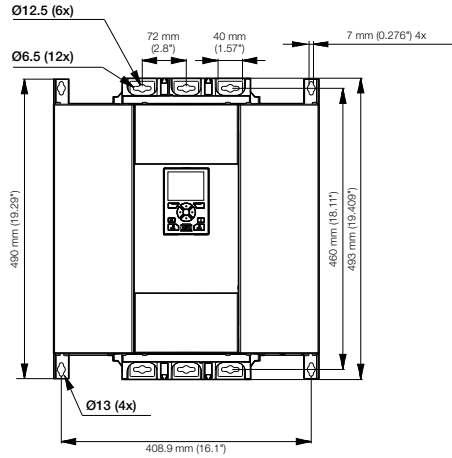
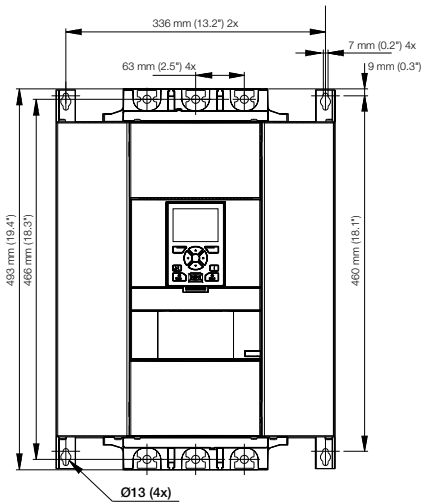
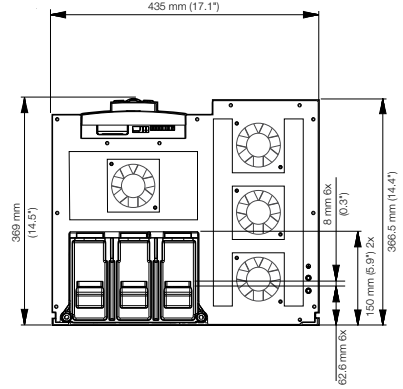

PSTX1250

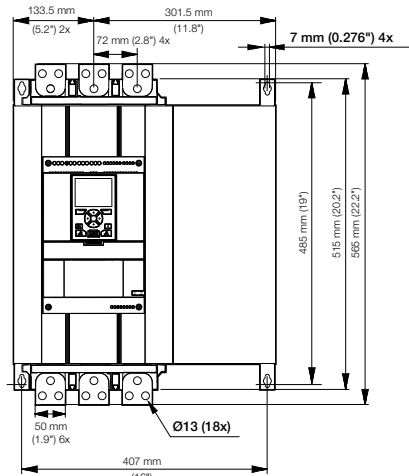
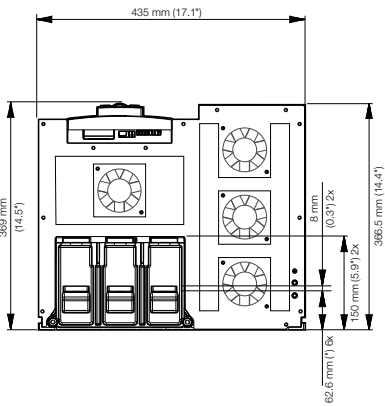

PSTX - The advanced range

Circuit diagrams

PSTX30...PSTX1250 IEC circuit diagram



CAUTION

Terminal 22  is a function earth, it is not a protective earth. It should be connected to the mounting plate.

4

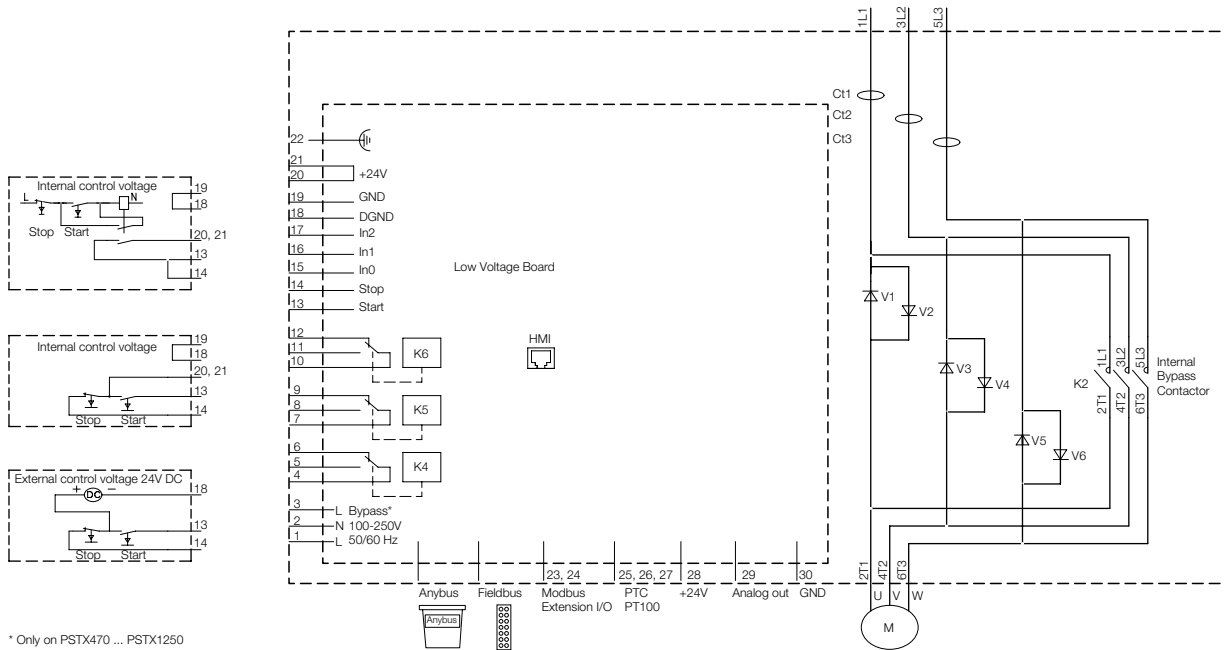

* Only on PSTX470 ... PSTX1250

UL circuit diagram

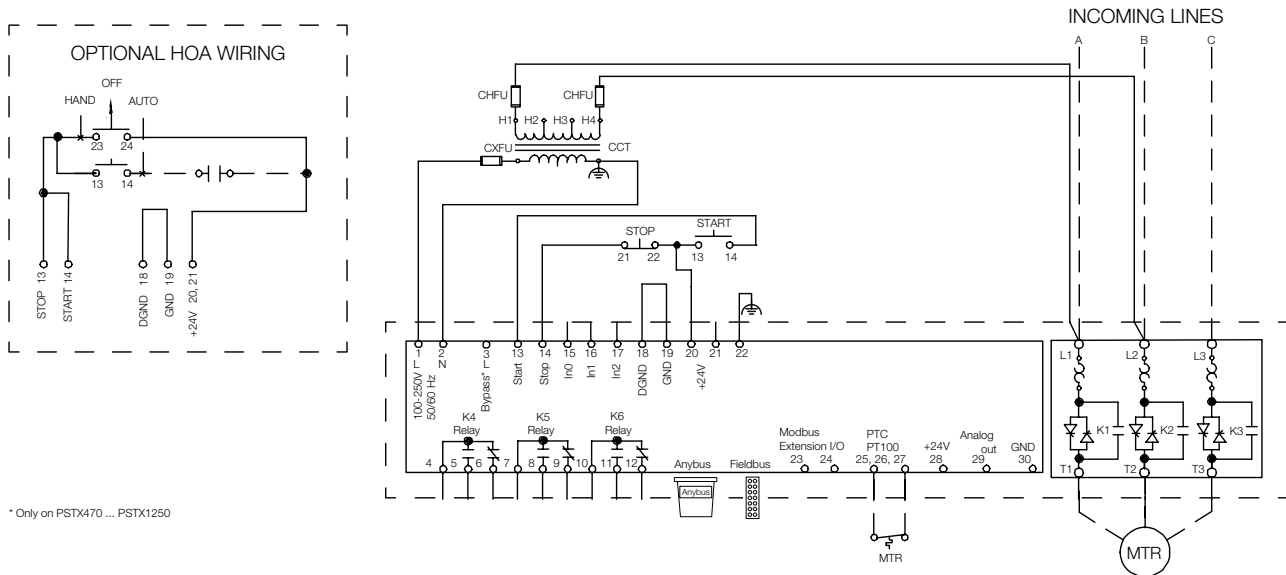

* Only on PSTX470 ... PSTX1250

For more circuit diagrams see new.abb.com/low-voltage/products/softstarters.

PSTX - The advanced range

Circuit diagrams

PSTX30...PSTX1250

In-line connected with line contactor and fuses

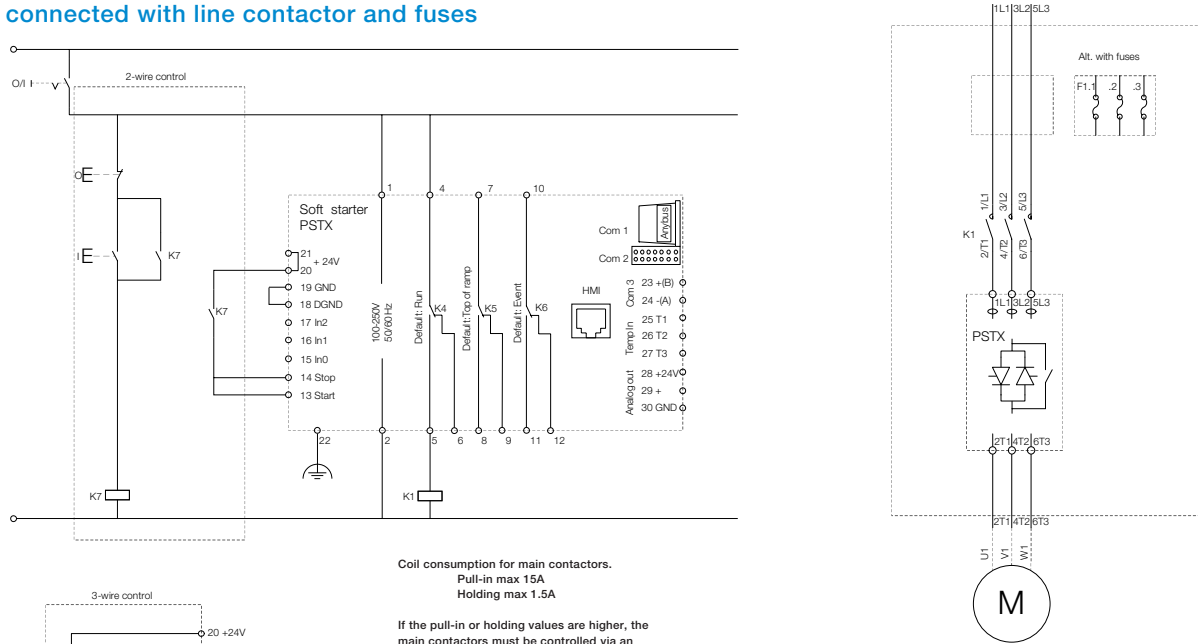

Inside-delta connected with contactor and fuses

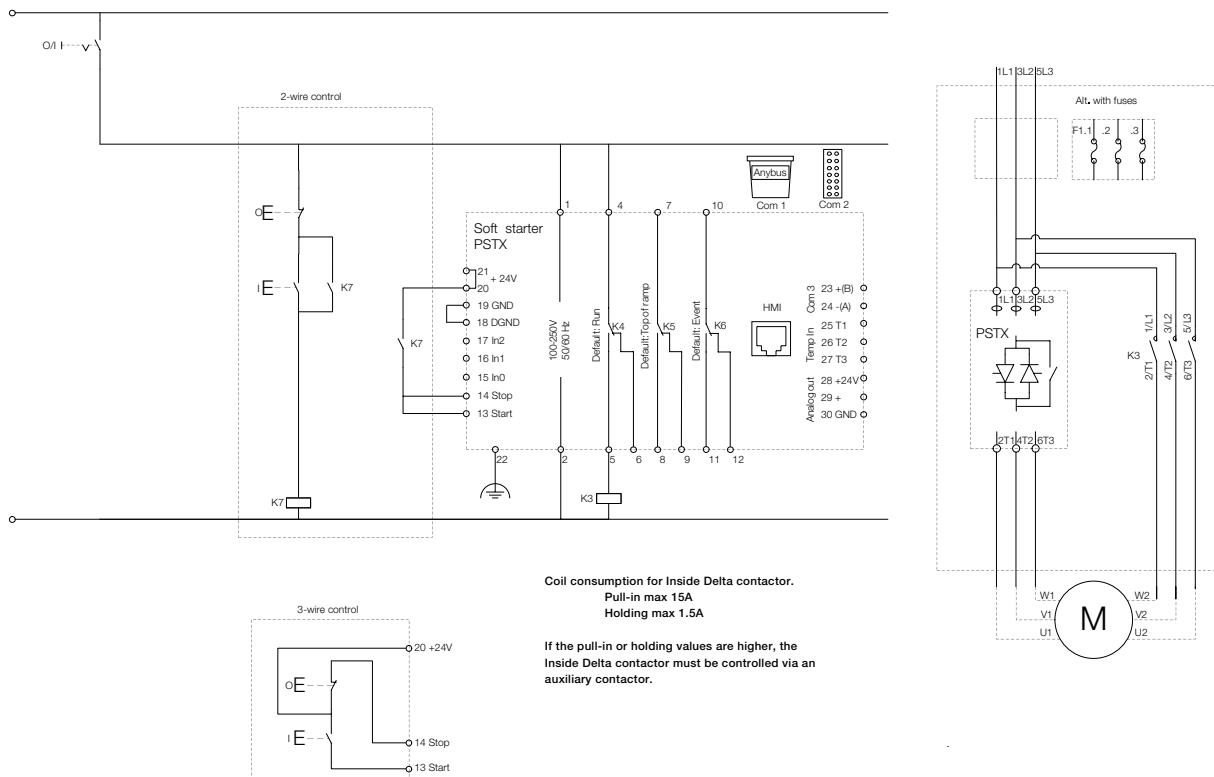



Fieldbus communication

Fieldbus communication

Introduction	5/2
Anybus ordering details	5/3
FieldBusPlug ordering details	5/4
FieldBusPlug accessories ordering details	5/6

Fieldbus communication

Introduction

PSR, PSE and PSTX softstarters can be connected to a fieldbus network for monitoring and control. All major industrial fieldbus protocols include different accessories, making the installation very flexible.

5

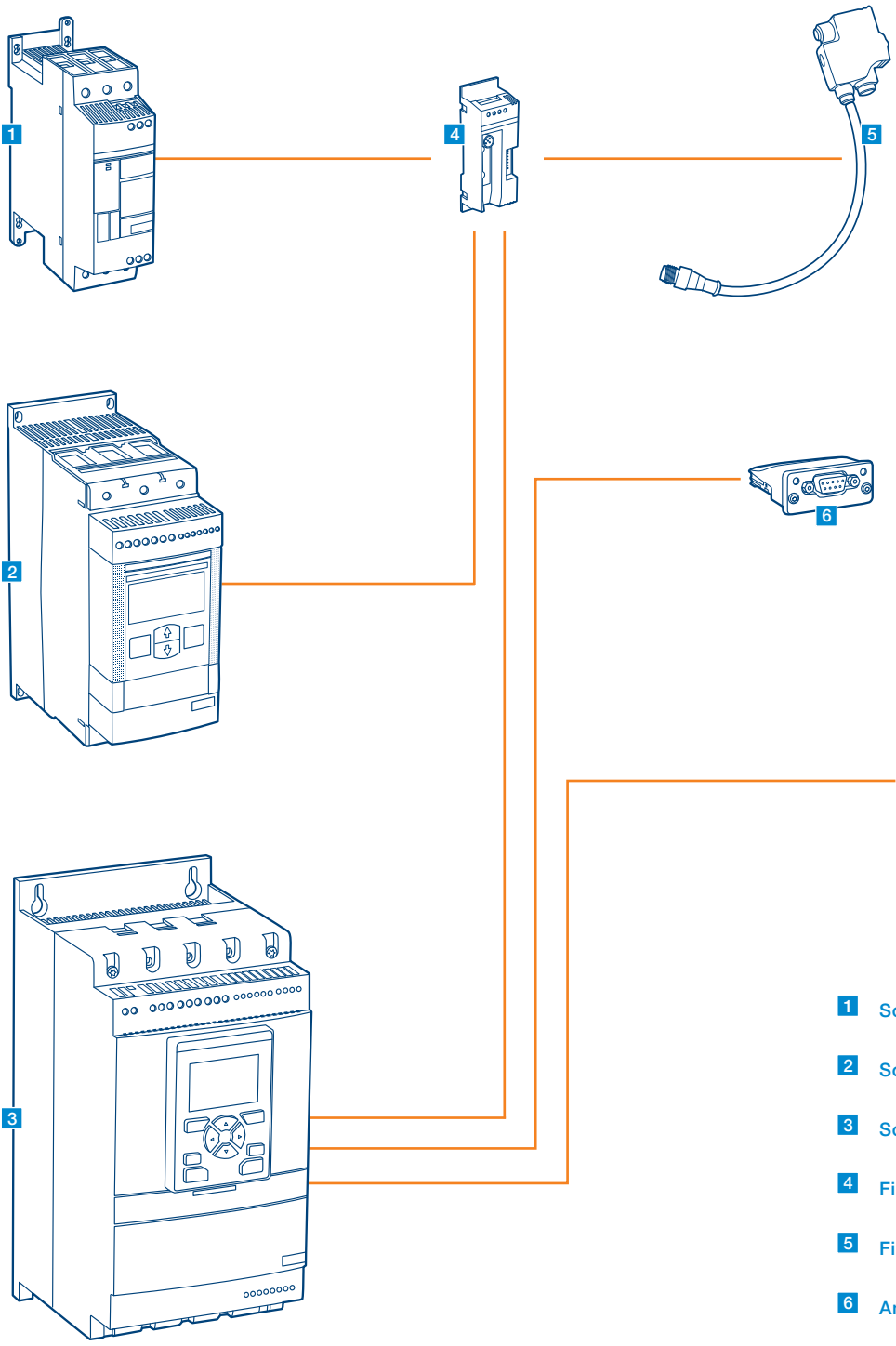

Protocols with FieldBusPlug

- Modbus-RTU
- Profibus
- DeviceNet
- Modbus TCP (only PSE)

Protocols with Anybus

- Modbus-RTU
- Profibus
- DeviceNet
- EtherNet/IP
- Modbus TCP
- Profinet

Integrated protocol

- Modbus-RTU

- 1** Softstarter PSR
- 2** Softstarter PSE
- 3** Softstarter PSTX
- 4** FieldBusPlug adapter
- 5** FieldBusPlug
- 6** Anybus

Fieldbus communication

Anybus ordering details



Profibus
Modbus-RTU

1SFC132120V0001



DeviceNet

1SFC132121V0001



EtherNet/IP (1-port)
Modbus TCP (1-port)

1SFC132118V0001



EtherNet/IP (2-port)
Modbus TCP (2-port)
Profinet (2-port)

1SFC132119V0001

For communication protocol	Catalog number	Global reference code	Pkg qty	Weight (1 pce)	
				kg	(lb)
Profibus	AB-PROFIBUS-1	1SFA899300R1001	1	0.042	(0.093)
DeviceNet	AB-DEVICENET-1	1SFA899300R1002	1	0.042	(0.093)
Modbus-RTU	AB-MODBUS-RTU-1	1SFA899300R1003	1	0.042	(0.093)
EtherNet/IP (1-port)	AB-ETHERNET-IP-1	1SFA899300R1005	1	0.042	(0.093)
EtherNet/IP (2-port)	AB-ETHERNET-IP-2	1SFA899300R1006	1	0.042	(0.093)
Modbus TCP (1-port)	AB-MODBUS-TCP-1	1SFA899300R1007	1	0.042	(0.093)
Modbus TCP (2-port)	AB-MODBUS-TCP-2	1SFA899300R1008	1	0.042	(0.093)
Profinet (2-port)	AB-PROFINET-2	1SFA899300R1010	1	0.042	(0.093)

Fieldbus communication

FieldBusPlug ordering details

Black cable 



DeviceNet FieldBusPlug

- Ready-made DeviceNet fieldbus interface with various cable lengths
- Applicable on all FBP motor starters and other devices
- Degree of protection IP65, diagnostic LED

Designation	Cable length	Catalog number	Global reference code	Pkg qty	Weight (1 pce)	
					kg	(lb)
DeviceNet-FBP	0.25 m	DNP21-FBP.025	1SAJ230000R1003	1	0.09	(0.20)
DeviceNet-FBP	0.50 m	DNP21-FBP.050	1SAJ230000R1005	1	0.10	(0.22)
DeviceNet-FBP	1.00 m	DNP21-FBP.100	1SAJ230000R1010	1	0.13	(0.29)
DeviceNet-FBP	5.00 m	DNP21-FBP.500	1SAJ230000R1050	1	0.36	(0.79)

Modbus-RTU FieldBusPlug

- Ready-made Modbus-RTU fieldbus interface with various cable lengths
- Applicable on all FBP motor starters and other devices
- Degree of protection IP65, diagnostic LED

Designation	Cable length	Catalog number	Global reference code	Pkg qty	Weight (1 pce)	
					kg	(lb)
MODBUS-RTU-FBP	0.25 m	MRP21-FBP.025	1SAJ250000R0003	1	0.09	(0.20)
MODBUS-RTU-FBP	0.50 m	MRP21-FBP.050	1SAJ250000R0005	1	0.10	(0.22)
MODBUS-RTU-FBP	1.00 m	MRP21-FBP.100	1SAJ250000R0010	1	0.13	(0.29)
MODBUS-RTU-FBP	5.00 m	MRP21-FBP.500	1SAJ250000R0050	1	0.36	(0.79)

Ethernet Modbus TCP interface MTQ22-FBP

- Ethernet connectivity for up to four units
- Modbus TCP protocol
- Supports all network topologies
- No special Ethernet connectors required in MCCs
- Easy to use in withdrawable applications

Designation	Cable length	Catalog number	Global reference code	Pkg qty	Weight (1 pce)	
					kg	(lb)
Ethernet Modbus TCP interface		MTQ22-FBP	1SAJ260000R0100	1	0.20	(0.44)
Cable MTQ to FieldBusPlug adapter	1.5 m	CDP17-FBP.150	1SAJ929170R0015	1	0.01	(0.02)
Passive cable fixing bracket		CDP11-FBP.4	1SAJ929100R0004	4	0.01	(0.02)

To connect the softstarter to a Profibus DP fieldbus system...

you need specific software for PLC setup, (GSD file) which is available at new.abb.com/low-voltage/products/softstarters
If you need help or advice, please contact your local ABB office.

5



DNP21-FBP
MRP21-FBP
COP21-FBP



MTQ22-FBP

Fieldbus communication

FieldBusPlug ordering details



PDP22-FBP

Profibus DP FieldBusPlug

- Ready-made Profibus DP fieldbus interface with various cable lengths.
- Supports PROFIBUS DP V0 and V1
- Applicable on all FBP motor starters and other devices
- Degree of protection IP65, diagnostic LED



Designation	Cable length	Catalog number	Global reference code	Pkg qty	Weight (1 pce) kg	(lb)
Profibus DP FBP	0.25 m	PDP22-FBP.025	1SAJ240100R1003	1	0.09	(0.20)
Profibus DP FBP	0.50 m	PDP22-FBP.050	1SAJ240100R1005	1	0.10	(0.22)
Profibus DP FBP	1.00 m	PDP22-FBP.100	1SAJ240100R1010	1	0.13	(0.29)
Profibus DP FBP	2.00 m	PDP22-FBP.200	1SAJ240100R1020	1	0.20	(0.44)
Profibus DP FBP	5.00 m	PDP22-FBP.500	1SAJ240100R1050	1	0.36	(0.79)

5



PDQ22-FBP

Profibus DP FieldBusPlug for four devices

- PDQ22 is a member of the ABB FieldBusPlug family of bus connectors. It allows the connection of up to four devices to Profibus DP by just using one Profibus node access. This allows a cost-efficient device integration for devices that are physically located nearby. PDQ22 supports DP-V0 and DP-V1. The degree of protection is IP66. There are separate diagnosis LEDs for bus and device status.

Note that the accessory PDQ22-FBP only works with the PSR and PSE softstarter.

Designation	Catalog number	Global reference code	Pkg qty	Weight (1 pce) kg	(lb)
Quadruple bus connector	PDQ22-FBP	1SAJ240200R0050	1	0.20	(0.44)
DIN rail adapter for PDQ22-FBP	CDA11-FBP.0	1SAJ929300R0001	1	0.11	(0.24)
Fixing bracket for passive plug of connection cable	CDP11-FBP.0	1SAJ929100R0001	1	0.50	(1.10)

Configuration software

- This cable and software can be used for setup and commissioning of the softstarter as well as to keep back-up of the parameter settings.



2CD0C34101S010

Designation	Catalog number	Global reference code	Pkg qty	Weight (1 pce) kg	(lb)
USB to FBP interface cable	UTF21-FBP	1SAJ929400R0002	1	0.01	(0.02)
PDP22/PDQ22 Device Type Manager (DTM) incl. FDT/DTM frame application	PBDTM-FBP	1SAJ924012R0005	1	-	-

To connect the softstarter to a Profibus DP fieldbus system...

you need specific software for PLC setup, (GSD file) which is available at new.abb.com/low-voltage/products/softstarters
If you need help or advice, please contact your local ABB office.

Fieldbus communication

FieldBusPlug accessories ordering details

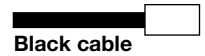

5



DNF11-FBP.050



DNM11-FBP.050



DNX11-FBP



DNM11-FBP.0

DNF11-FBP.0



DNR11-FBP.120

Accessories for the DeviceNet and Modbus-RTU bus connector



DeviceNet and Modbus-RTU round cable for bus junctions

Ready-made bus cable with an M12 connector and an open cable end

Designation	Cable length	Catalog number	Global reference code	Pkg qty	Weight (1 pce)
					kg (lb)
Round cable with female connector	0.50 m	DNF11-FBP.050	1SAJ923002R0005	1	0.04 (0.09)
Round cable with male connector	0.50 m	DNM11-FBP.050	1SAJ923003R0005	1	0.04 (0.09)

Devicenet and Modbus-RTU round cable for bus extension

Ready-made bus cable with M12 male and female connectors

Designation	Cable length	Catalog number	Global reference code	Pkg qty	Weight (1 pce)
					kg (lb)
Extension cable	1.00 m	DNX11-FBP.100	1SAJ923001R0010	1	0.08 (0.18)
Extension cable	3.00 m	DNX11-FBP.300	1SAJ923001R0030	1	0.20 (0.44)
Extension cable	5.00 m	DNX11-FBP.500	1SAJ923001R0050	1	0.31 (0.68)
Round cable	100.00 m	DNC11-FBP.999	1SAJ923004R0001	1	5.60 (12.35)

DeviceNet and Modbus-RTU round cable connectors

Bus cable and coupling accessories

Designation	Catalog number	Global reference code	Pkg qty	Weight (1 pce)
				kg (lb)
Male connector for round cable	DNM11-FBP.0	1SAJ923005R0001	5	0.15 (0.33)
Female connector for round cable	DNF11-FBP.0	1SAJ923006R0001	5	0.15 (0.33)

DeviceNet and Modbus-RTU termination resistor

Designation	Catalog number	Global reference code	Pkg qty	Weight (1 pce)
				kg (lb)
Termination Resistor, 120 Ohm	DNR11-FBP.120	1SAJ923007R0001	1	0.02 (0.04)

Fieldbus communication

FieldBusPlug accessories ordering details



Accessories for the Profibus DP Bus Connector Profibus DP Round cable for Bus Junctions

- Ready-made bus cable with an M12 connector and an open cable end.
- Application on bus junctions such as e.g. Profibus DB couplers or devices with an integrated Profibus DB interface



Designation	Cable length	Catalog number	Global reference code	Pkg qty	Weight (1 pce)	
					kg	(lb)
Round cable with female connector	0.50 m	PDF11-FBP.050	1SAJ924002R0005	1	0.04	(0.09)
Round cable with male connector	0.50 m	PDM11-FBP.050	1SAJ924003R0005	1	0.04	(0.09)



Profibus DP round cable for bus extension

- Ready-made bus cable with M12 male and female connectors
- Round cable on coil

Designation	Cable length	Catalog number	Global reference code	Pkg qty	Weight (1 pce)	
					kg	(lb)
Extension cable	0.50 m	PDX11-FBP.050	1SAJ924001R0005	1	0.04	(0.09)
Extension cable	1.00 m	PDX11-FBP.100	1SAJ924001R0010	1	0.08	(0.18)
Extension cable	3.00 m	PDX11-FBP.300	1SAJ924001R0030	1	0.20	(0.44)
Extension cable	5.00 m	PDX11-FBP.500	1SAJ924001R0050	1	0.31	(0.68)
Round cable	100.00 m	PDC11-FBP.999	1SAJ924004R1000	1	5.60	(12.35)

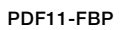

Profibus DP accessories for bus extension

Designation	Catalog number	Global reference code	Pkg qty	Weight (1 pce)	
				kg	(lb)
Male connector for round cable	PDM11-FBP.0	1SAJ924005R0001	5	0.03	(0.07)
Female connector for round cable	PDF11-FBP.0	1SAJ924006R0001	5	0.03	(0.07)

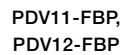

Profibus DP termination resistor, miscellaneous accessories

Designation	Catalog number	Global reference code	Pkg qty	Weight (1 pce)	
				kg	(lb)
Termination resistor, 150 Ohm	PDR11-FBP.150	1SAJ924007R0001	1	0.03	(0.07)
Feeding connector 24 V DC, Code B-A	PDV11-FBP.0	1SAJ924008R0001	1	0.04	(0.09)
Feeding connector 24 V DC, Code A-A	PDV12-FBP.0	1SAJ924011R0001	1	0.04	(0.09)
Adaptor M12-Dsub9-M12 Cable length 0.50 m	PDA11-FBP.050	1SAJ924009R0001	1	0.04	(0.09)
Adaptor M12-Dsub9-M12 Cable length 2 x 0.50 m	PDA12-FBP.050	1SAJ924010R0001	1	0.04	(0.09)



Extension cable

Designation	Cable length	Catalog number	Global reference code	Pkg qty	Weight (1 pce)	
					kg	(lb)
Extension cable (female/male), shielded	0.3 m	CDP15-FBP.030	1SAJ929140R0003	1	0.01	(0.02)
Extension cable (female/male), shielded	0.6 m	CDP15-FBP.060	1SAJ929140R0006	1	0.01	(0.02)
Extension cable (female/male), shielded	1.5 m	CDP15-FBP.150	1SAJ929140R0015	1	0.20	(0.44)
Extension cable (male/open), shielded	1.5 m	CDP16-FBP.150	1SAJ929150R0015	1	0.20	(0.44)

ABB softstarters

Marketing material and tools

It is easy to access more information about ABB softstarters online. On our web page you will find tools for selection, coordination tables, CAD drawings and a variety of documentation.

6

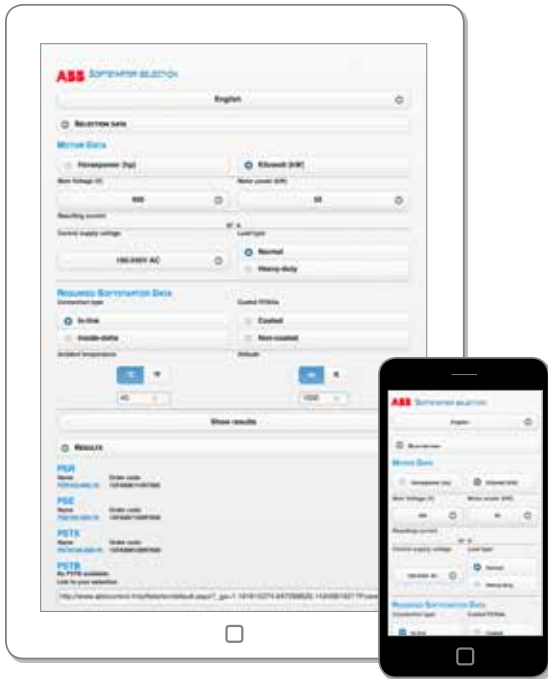

Online softstarter selection tool

Fast and easy selection of softstarter on any device.



www.abbcontrol.fr/softstarter

Coordination tables

Online tool for coordination with short circuit protection, overload protection and line contactor.



applications.it.abb.com/SOC

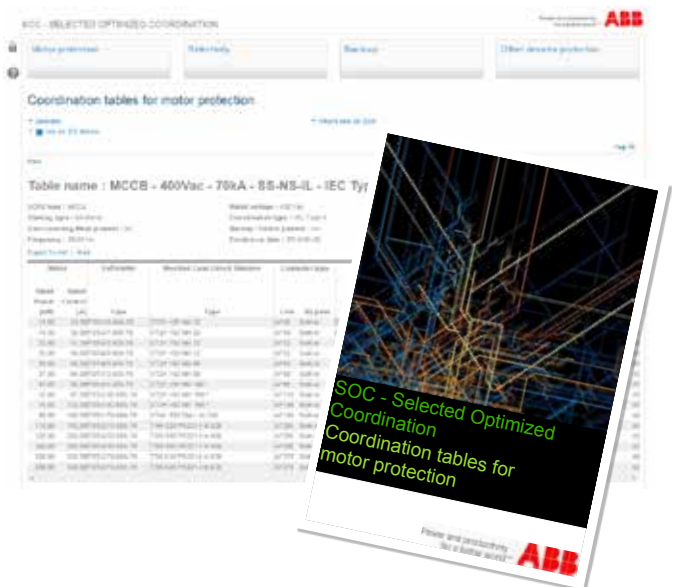

Download 2D and 3D drawings in any format

Use our Cadenas portal to download CAD drawings for all of our softstarters.



Cadenas portal for CAD drawings

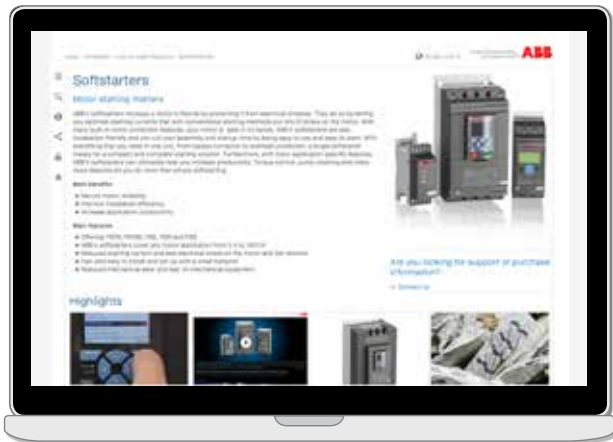
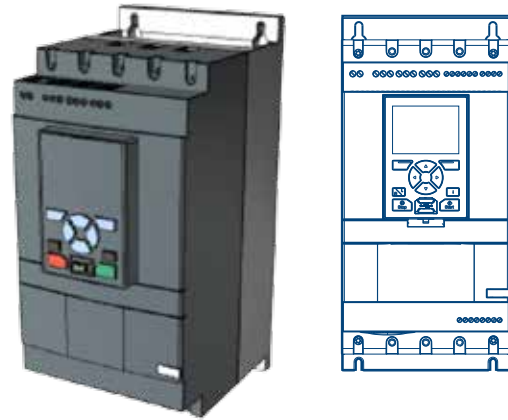

More information online

- Product catalogs and brochures
- Certificates and approvals
- Case studies
- Product simulator
- Circuit diagrams and application diagrams
- Manuals
- EDS- and GSD-files for fieldbus connection
- Softstarter selection tool



new.abb.com/low-voltage/products/softstarters



<http://new.abb.com/low-voltage/launches/pstx>

SoftstarterCare™ – Service Engineer Tool

Software for easy set-up of PSE and PSTX, using a PC.



new.abb.com/low-voltage/products/softstarters



Contact us

ABB

Electrification Products
8155 T&B Boulevard
Memphis, TN 38125
www.abb.us/lowvoltage

Customer Service: 800-816-7809
7:00 a.m. - 5:30 p.m., CST, Monday-Friday
elec_custserv@tnb.com
Technical Support: 888-385-1221, Option 1
7:00 a.m. - 5:00 p.m., CST, Monday-Friday
lvps.support@us.abb.com



We reserve the right to make technical changes or modify the contents of this document without prior notice. With regard to purchase orders and/or contracts, the agreed particulars shall prevail. ABB does not accept any responsibility whatsoever for potential errors or possible lack of information in this document. We reserve all rights in this document and in the subject matter and illustrations contained therein. Any reproduction, disclosure to third parties or utilization of its contents – in whole or in parts – is forbidden without prior written consent of ABB.

© Copyright 2016 ABB. All rights reserved.