

NOJA POWER[®]

Empower the world.



OSM[®]

AUTOMATIC CIRCUIT RECLOSER

The World's
Safest Recloser

PRODUCT GUIDE
15kV/27kV/38kV MODELS

NOJA POWER[®]

Empower the world.

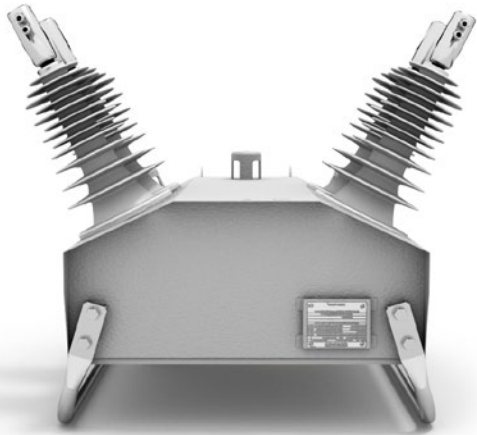
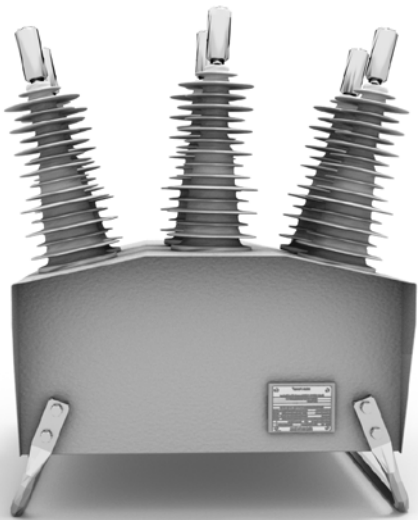



OSM Recloser

A Testament to Safety and Reliability in Distribution Switchgear

OSM Recloser

Introduction – Overview

At the forefront of switchgear technology, the NOJA Power OSM Recloser represents the state of the art in distribution switchgear. This rugged unit provides unrivalled safety, reliability and innovation, with a pedigree unmatched by any other distribution switchgear equipment.

Proven through over 80,000 global installations in more than 104 countries over the full industrial temperature range, this stainless-steel paragon is deserved of its reputation as the world's ultimate recloser.

Meticulously hand crafted in Australia and fully type tested to industry standards, the OSM Recloser delivers exceptional performance in even the most demanding environments. Through use of solid dielectric insulation and vacuum interruption technology, the OSM Recloser is maintenance free and easy to install.

OSM Reclosers sport class defining voltage and current sensors with exceptional accuracy and precision. Driven by patented proprietary design, the OSM Recloser achieves current protection resolution increments of 100mA, a feat yet unmatched in other integrated distribution protection assets. Advanced protection capabilities including Synchrocheck, Broken Conductor Protection and Admittance protection equip astute protection engineers with the tools to drive unprecedented network reliability, even as the distribution grid becomes more complex.

Deployed as a Recloser, Sectionalizer or Automated Switch, the sheer versatility and operation simplicity of the OSM Recloser has solved thousands of protection and automation challenges around the globe, from out on the feeders to inside the substation.

As the world transitions to distributed energy and renewable integration as standard, OSM Reclosers are the only sure device to still be on the pole at the end of their 30 year life.

This is the OSM Recloser.



OSM Recloser

Key Features at a glance

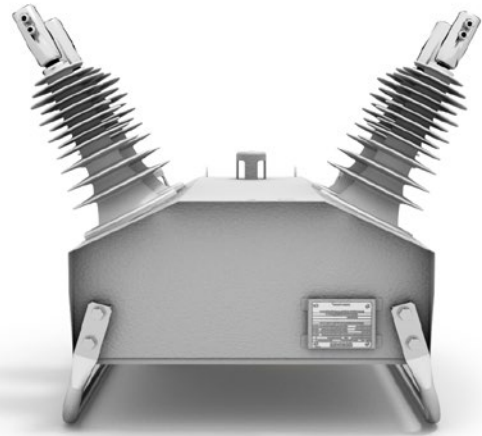
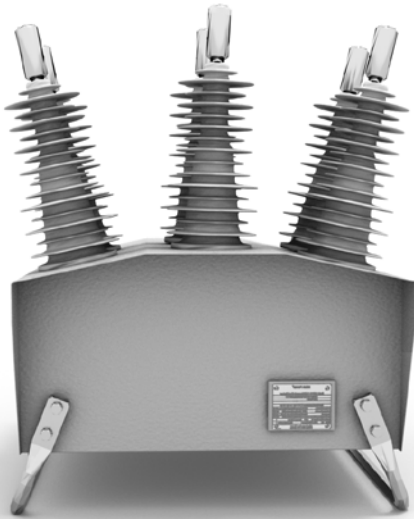

ULTIMATE SAFETY AND SERVICE

- » The World's Only Arc Fault Vented Solid Dielectric Recloser
- » Designed for a maintenance free life
- » Supported by an international network of Technical Staff
- » Ganged ultra-fast magnetic actuators to provide additional operator safety
- » Hot Line Tag functionality and Mechanical trip interlock directly connected to the OSM tank's operating mechanism
- » Unique and seamless NOJA Power Android and iOS App enhances linesmen comfort and safety
- » Internal double pole position indicator micro switches for added reliability
- » Triple shielded, water blocked and metal conduit protected control cable with military grade IP65 rated connectors
- » Grey powder coated tank to prevent drivers from being blinded by the sunlight reflecting on the tank
- » Only 3 electronic modules in total that can be replaced within 5 minutes with a simple screwdriver
- » Remote and quick firmware upgrades to keep up with the industry changes over time

ULTIMATE INNOVATION

- » Class Defining Current and Voltage Sensors, included on both load and source side of the device as standard.
- » Full Automation, Logic and Synchronising Feeder Capability as standard
- » Over 100 different protection features, from the simplest Overcurrent and Earth Fault Protection through to Admittance, Fault Locator and Harmonic Protection
- » No Active Electronics in the Recloser Tank – Providing exceptional surge immunity and reliability

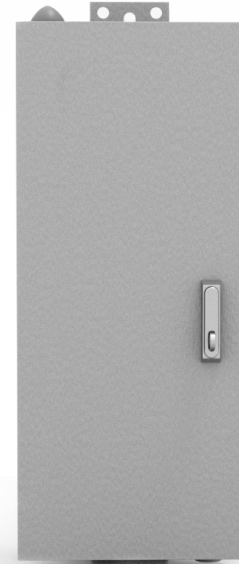

UNMATCHED RELIABILITY

- » Total Stainless Steel External Construction
- » Full Industrial Temperature Range -40°C to +55°C
- » Proven Performance through decades in service
- » 80,000 Reclosers in Service Worldwide and Counting
- » Featuring the most reliable vacuum interrupter (VI) technology in the world today with radial magnetic field contacts to quickly diffuse the arc and maximise the life of the VI
- » Medium Time Between Failures (MTBF) of 850 years for a complete unit
- » Proprietary OSM tank design to eliminate partial discharges and minimise electrical stress
- » Aromatic epoxy poles encapsulated within a stainless steel tank so not exposed to UV radiation
- » Rating of 30,000 operations at full load, 3 times the industry's standard of 10,000 operations
- » Seamless Smart-Grid Interoperability with embedded third party type tested and expert level communication protocol implementations
- » Unique ceramic shielded temperature controlling RC control design
- » On board powerful processor and FPGE running diagnostics 24/7
- » RC control fitted with the industry's most powerful sealed, spill-proof and MAT lead acid 12Vdc and 26Ah battery
- » The RC controller's IP66 rating completely eliminates the need for heaters in cold climates or ventilation in tropical applications
- » EMC shielded Human Machine Interface (HMI) available in several languages and fitted inside an IP66 moisture and dust free RC Controller

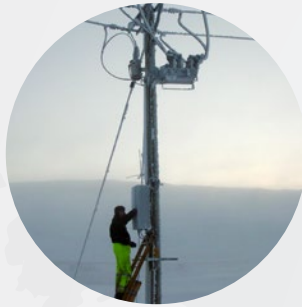

VOLTAGE RANGE, 6KV TO 38KV



SECTIONALISER



UNDERGROUND TO OVERHEAD CONNECTION



MOBILE FAULT FIRING TEST EQUIPMENT



SMART GRID SCHEMES



AUTO-CHANGEOVER SCHEMES

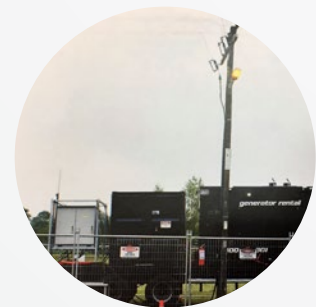

MOBILE SWITCHGEAR



ALARM SWITCH



REMOTE SWITCH



GENERATOR CONNECTION

OSM Recloser

ONE PRODUCT - MANY APPLICATIONS

Solving Energy Challenges
All Over the Distribution Network



MINE EQUIPMENT PROTECTION



SUBSTATION CIRCUIT BREAKER



RENEWABLE AND DISTRIBUTED
GENERATION CONNECTION

OSM Recloser System

The standard scope of supply

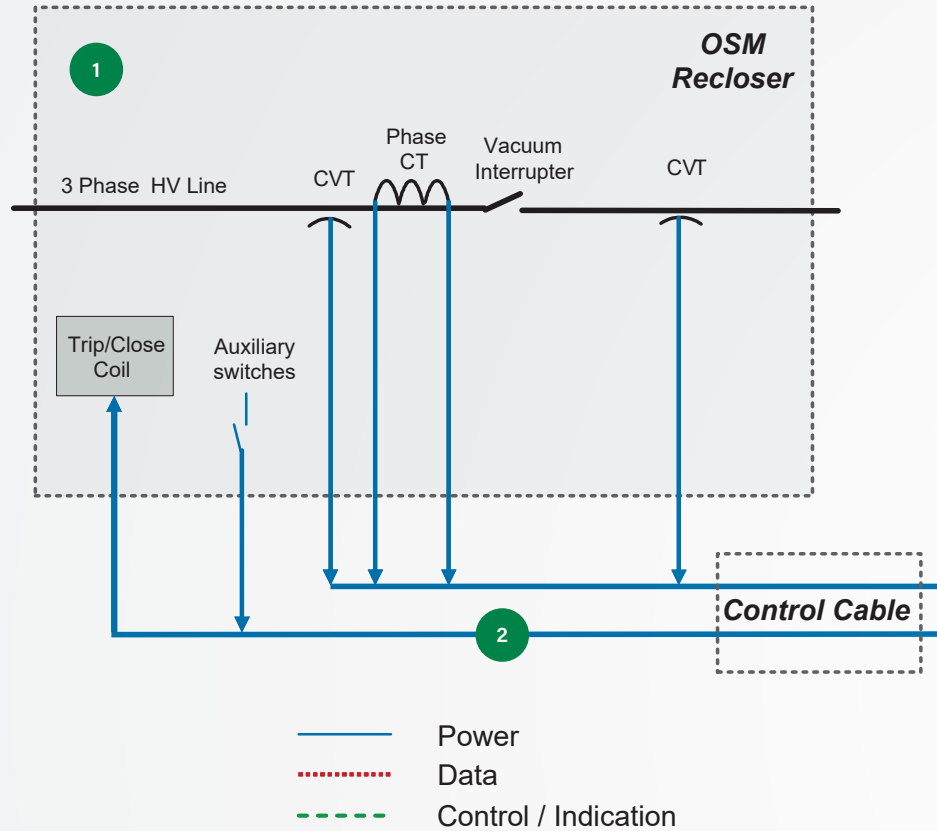

1

The OSM Recloser

- Solid Dielectric
- Vacuum Interruption
- Oil and SF6 Free
- Arc Fault Venting
- 3 Integrated Current Transformers
- 6 Integrated Voltage Sensors
- Fully Bidirectional Operation
- No Active Electronics
- Hermetically Sealed
- Stainless Steel Construction
- Complete with Steel Mounting Bracket



2

The NOJA Power Control Cable

- The Connection between Switchgear and Controller
- Fully Armoured Cable
- Ruggedized Stainless Steel Switchgear Connection
- Military Specification Controller Connection
- Vandal Proof, Sealed Control Cubicle Entry
- Hand Crafted and Tested in Brisbane Australia
- Length Options from 4m to 20m

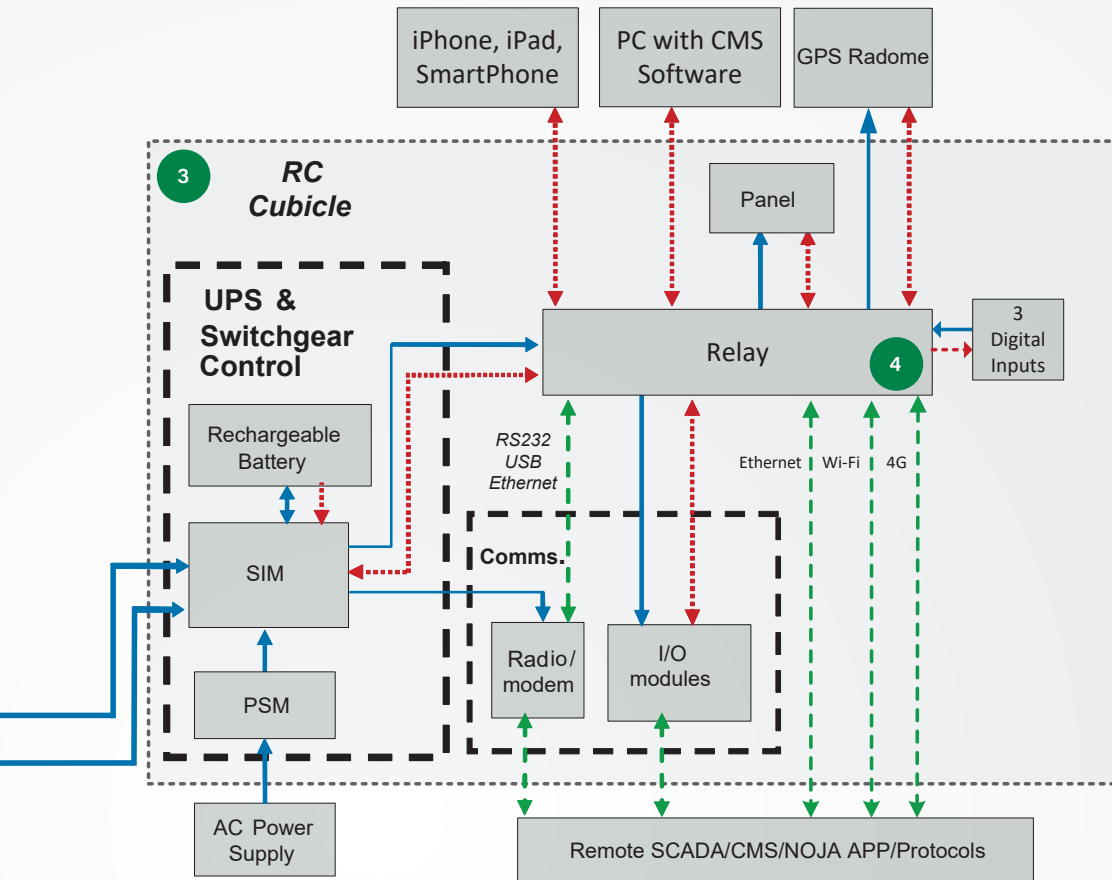

3

THE RC-10 OR RC-15 CONTROLLER

Powered by the NOJA Power Relay 10 or Relay 15

- Class Leading Comprehensive Protection, Communications, Power Quality Monitoring and Automation
- Integrated GPS for microsecond accurate event timestamping, no communications necessary (*RC-15 only*)
- DNP3, IEC 61850, IEC 60870-5-101/104 all standard
- Integrated 4G/3G/2G and WiFi (*RC-15 only*)
- IP66 Stainless Steel Enclosure
- 40 C to +55 C



4

THE NOJA POWER RELAY 15

At the core of the RC-15 Controller

- Advanced Industrial Computer with Multiple Processors
- Separate FPGA Signal Processing and Protection CPU
- Native Ethernet, USB, GPS, WiFi, RS232, 4G/3G/2G and Automotive tier MOLEX Connections
- Class Leading Protection, Automation and Communications Protocol Functionality
- Comprehensive Power Quality Monitoring
- Unrivalled Custom Logic Programming

OSM Recloser System

ANSI Standard Protection Diagram

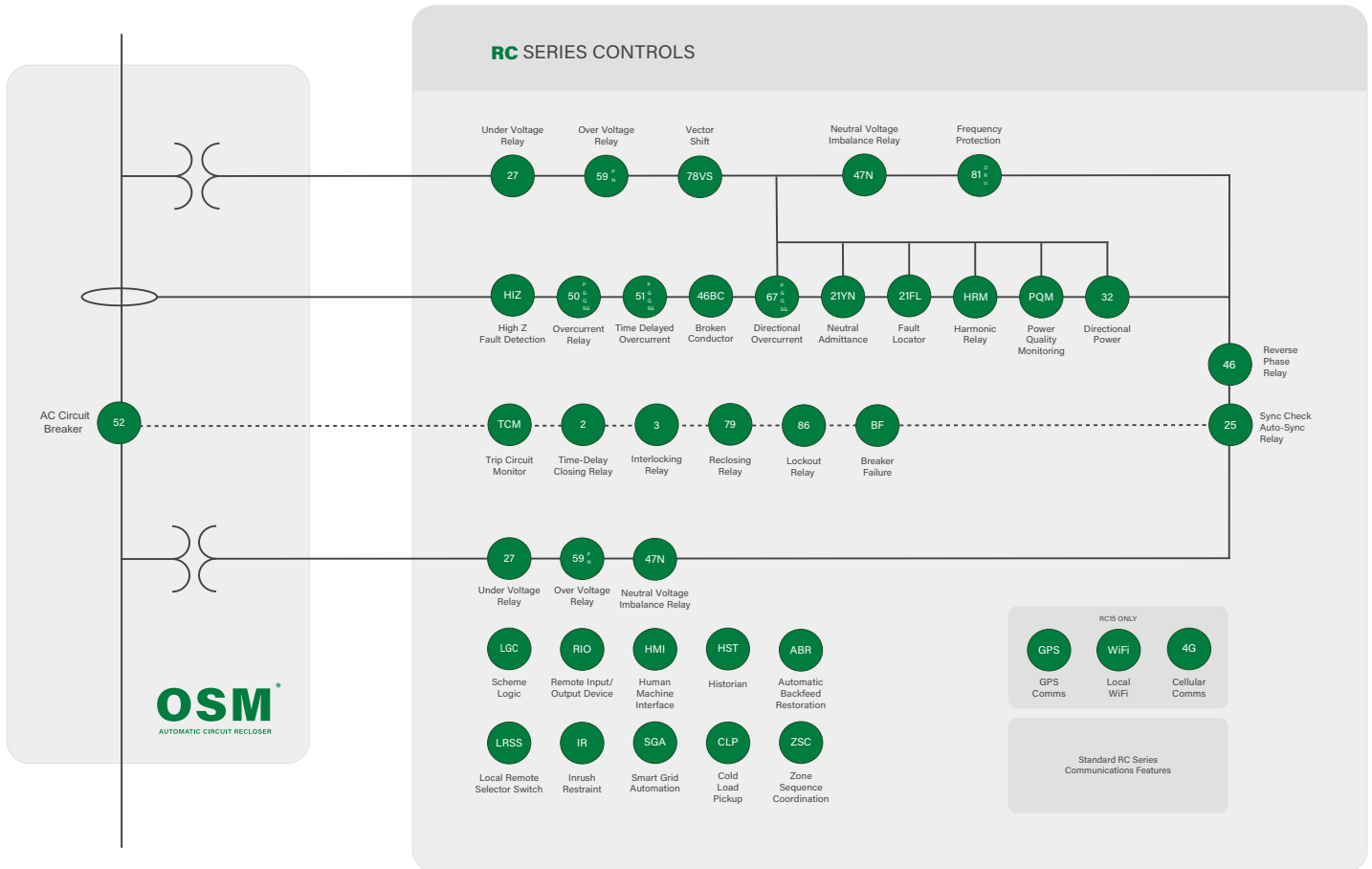



OSM Recloser

Switchgear Phase Variants

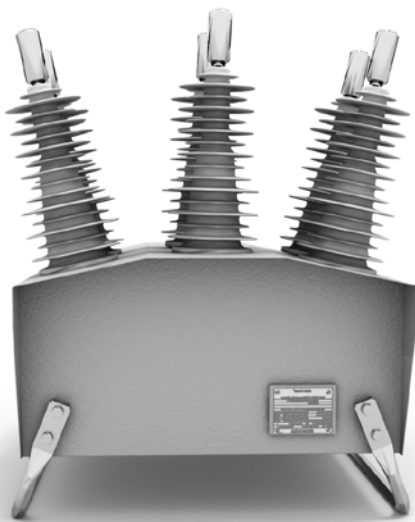

OSM THREE PHASE

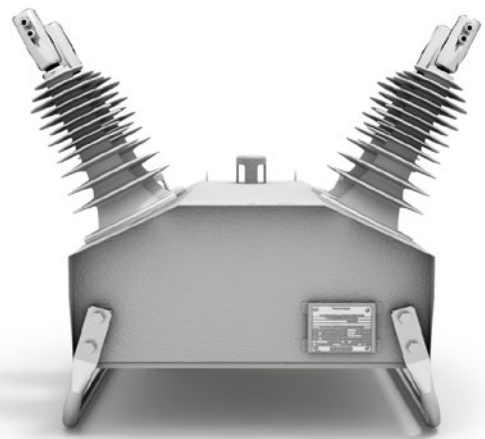

OSM TWO PHASE

The key interrupter architecture of the OSM Recloser can be deployed in four different variants. Ganged three-phase for 3-wire distribution systems, Two phase for 2 Wire Single Phase applications, Single Phase for Single Wire Earth Return (SWER) Applications, and un-ganged Three phase (Single Triple) for 4-wire overhead distribution systems.



OSM SINGLE PHASE

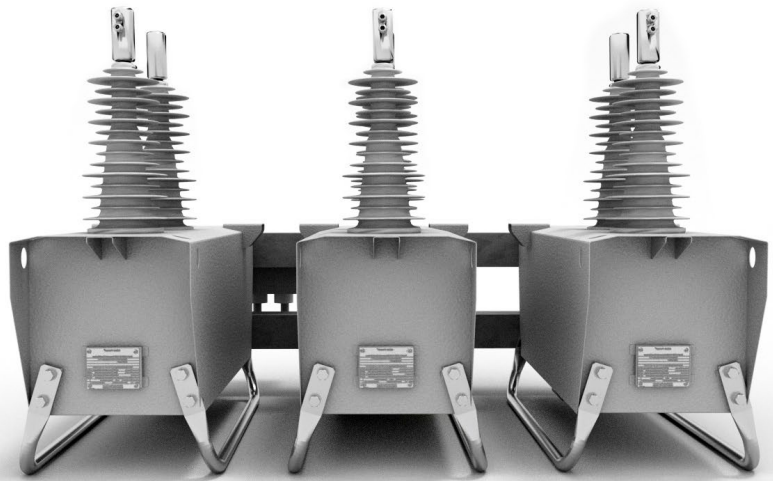

OSM SINGLE TRIPLE

CLASS	VOLTAGE RANGE	RATED CONTINUOUS CURRENT	FAULT MAKE CAPACITY RMS	IMPULSE ACROSS INTERRUPTER
OSM38-16	38kV	800A	16kA	170kV
OSM15	15kV	800A	16kA	110kV
OSM27	27kV	800A	12.5kA	150kV
OSM38	38kV	800A	12.5kA	170kV

OSM Recloser

Ultimate Safety

The World's Only Arc Fault Vented Solid Dielectric Recloser

NOJA Power is committed to improving safety for operators in the field. The NOJA Power OSM Recloser has a patented arc fault venting design, which allows for containment of internal arc faults and safe venting up and away from operators. Type tested and verified, arc fault venting in the OSM Recloser provides operators and the general public with greatly improved safety.

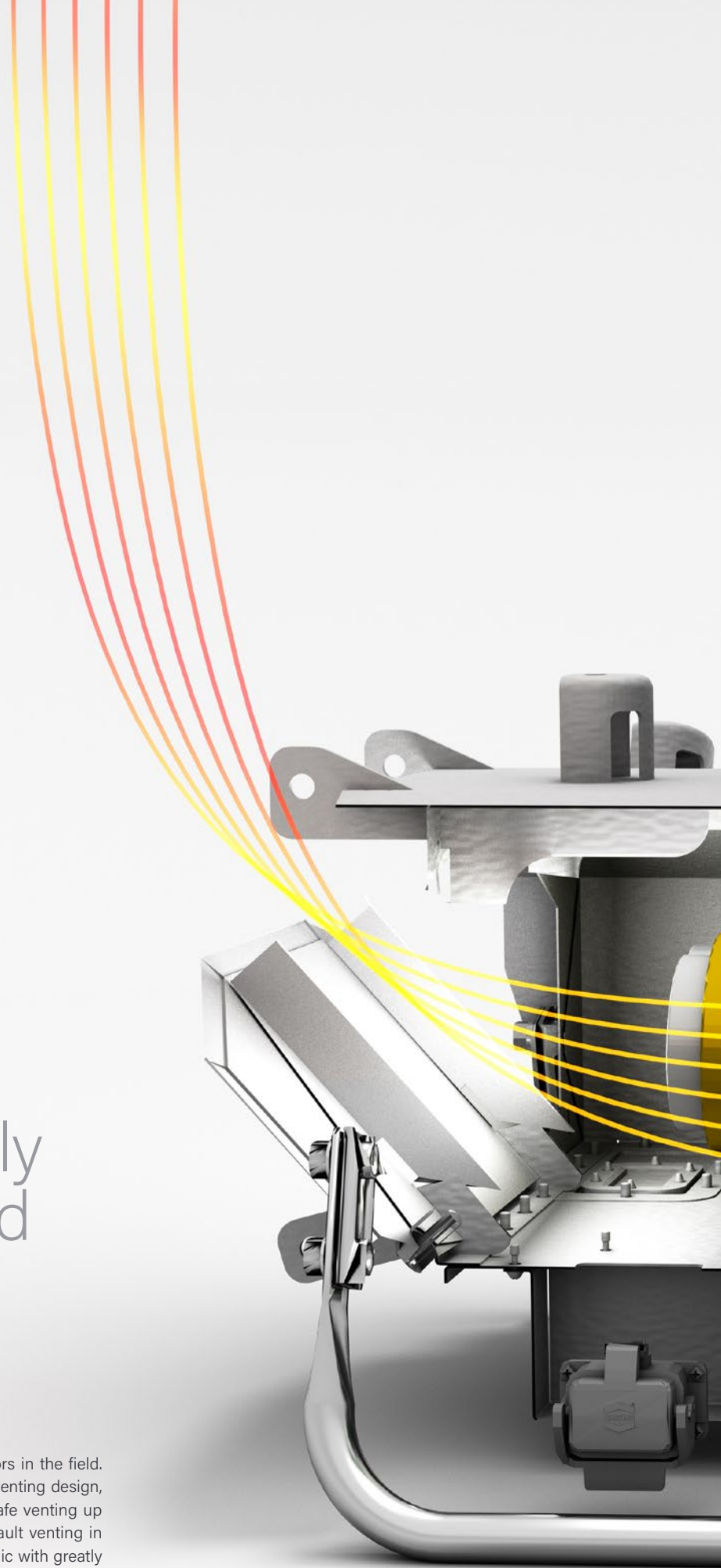

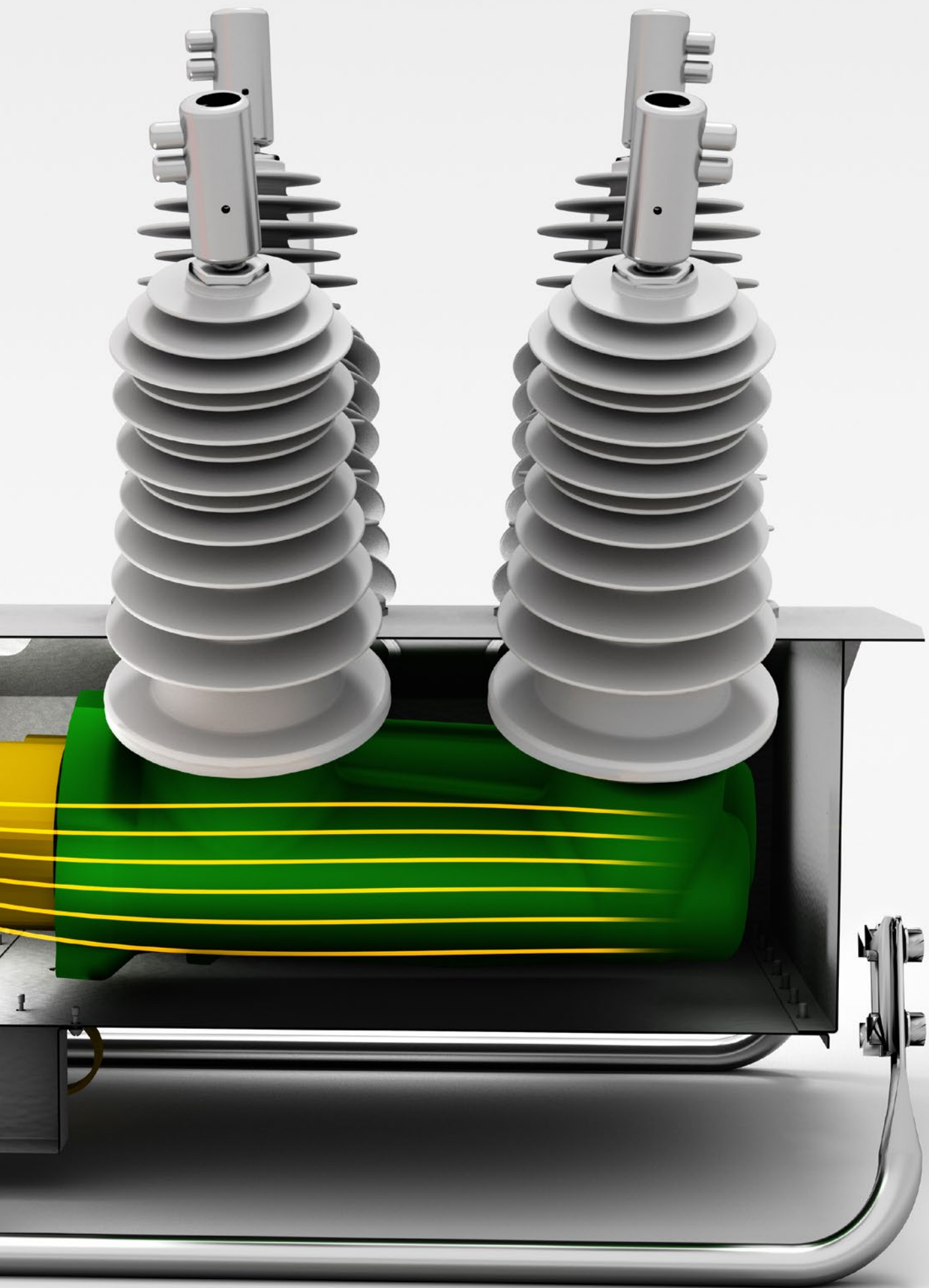



ZERO
SF6 GAS



SIMPLE
INSTALLATION



30,000
OPERATIONS



30 YEAR
SERVICE LIFE



SOLID
DIELECTRIC
INSULATION



OSM Recloser

Global Install Base

1



2

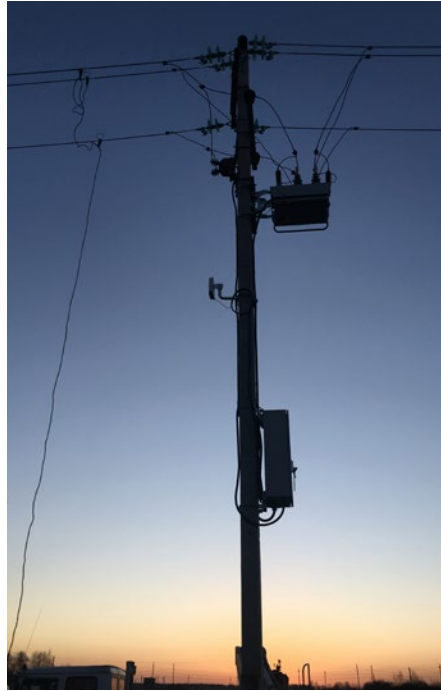

3

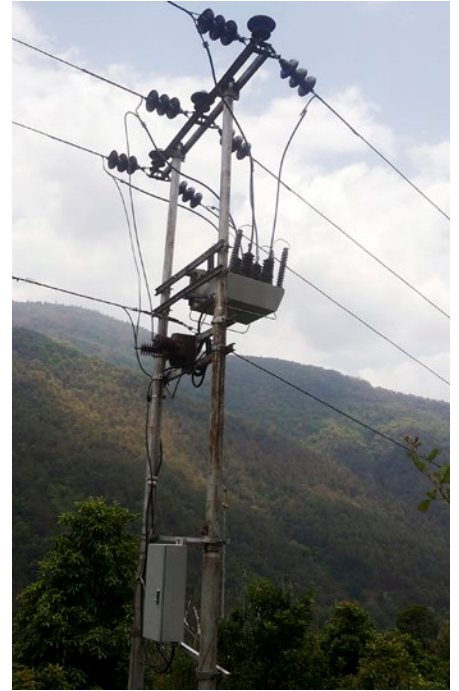

4



5



6

- 1. Australia
- 2. Belarus
- 3. Bhutan
- 4. Colombia

- 5. Poland
- 6. Finland
- 7. Mexico
- 8. Morocco

- 9. New Zealand
- 10. Portugal
- 11. Spain
- 12. Turkey

7



8



9



10



11



12

NOJA POWER[®]

Empower the world.

DRIVEN BY THE MOST ADVANCED
CONTROLLER AVAILABLE TODAY

The NOJA Power

RC Series Controls

Simplicity for operators but power for protection engineers, the integrated nature of the OSM Recloser system provides unparalleled control and automation for engineers yet a device which works immediately, straight out of the box.

NOJA Power's OSM Recloser System is controlled by the world's most advanced Autorecloser Control, the NOJA Power RC. Offered in two variants, the RC-10 and RC-15 differ only on extended communications capability, with the latter including integrated GPS, Secure WiFi and 4G Modem.

Designed in collaboration with some of the most forward-thinking utilities on earth, NOJA Power's RC-10 and RC-15 controllers provide the intelligence and precision relied upon by thousands of utility engineers.

When Distribution Networks evolve, the only asset with all the answers is the NOJA Power RC Control.



Hengenvaara

PAPPI

010



UTU

RC Controller

Key Features and Design Architecture



RC-15 Relay Module

CLASS LEADING PROTECTION

- » Full Directional Protection for Overcurrent, Earth Fault, Negative Phase Sequence and Sensitive Earth Faults, with advanced gate technology for responding to low fault currents
- » ANSI, IEC255 and User Defined Protection curve for ultimate flexibility
- » Instantaneous high set elements and definite time protection
- » The worlds' highest resolution SEF feature at 200mA minimum pickup*
- » Advanced Voltage, Current and Composite Protection such as Broken Conductor, Admittance and Harmonic Protection
- » Complete suite of Power Quality Monitoring and logging tools included as Standard.

UNRIVALLED AUTOMATION

- » Co-Generation functions standard, including ANSI25 Synchrocheck and Auto-Synchroniser
- » Over and Under Voltage Protection providing 3 Phase Load Shedding, Neutral Displacement, Loss of Phase and Loss of Supply Operation for advanced Automation schemes
- » Over and Under Frequency Protection with user programmable pickup range and operating time
- » Fully configurable Logic and Smart Grid Automation based on IEC61499 open source logic design

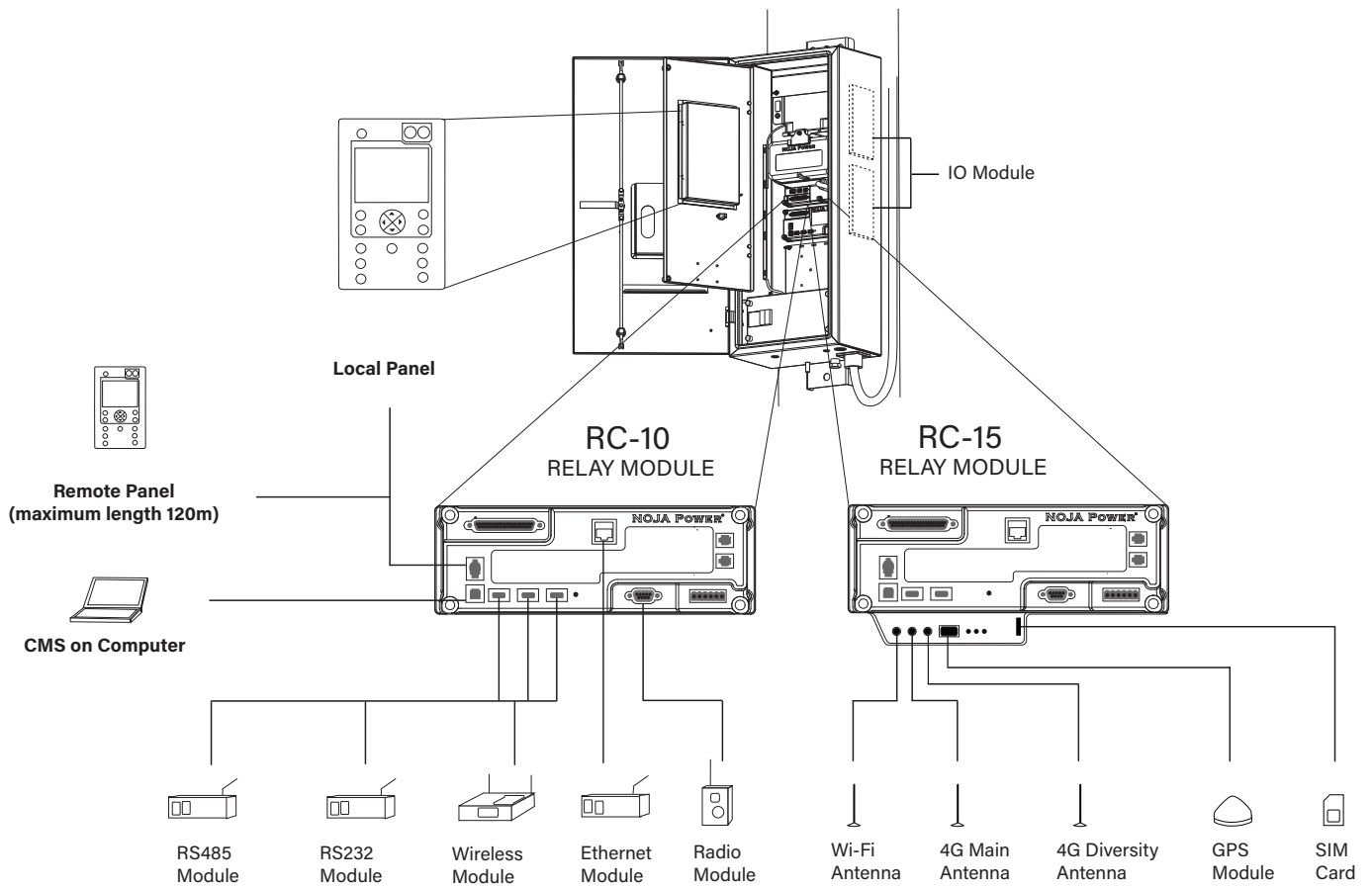

**PEERLESS LOGGING,
COMMUNICATIONS AND
DATA AVAILABILITY**

- » An event log for close open and fault protection operations, viewable on the massive 40x17 backlit LCD display. This provides operators with clear and concise field reports on recloser operation, including fault type, fault current and even distance to fault.
- » A detailed event log for all operating history and settings changes viewable through both the local panel or the supplied software
- » Easy loading and retrieval of protection settings using the CMS Software Package
- » Instantaneous Voltage, Current and Power metering viewable on the panel
- » Load profile data logger, logging comprehensive system parameters on a user configurable period
- » Integrated RTU offering DNP3, DNP3-SA, DNP3 over IP, IEC 618650 MMS and GOOSE, IEC 60870-5-101/104 and NOJA Power Proprietary Protocols
- » Best in Class Remote Control and SCADA
- » Innovative Secure Wireless Remote Control

RC-15 ONLY

- » All of the above, plus:
- » Integrated Secure WiFi
- » Integrated GPS for precise timestamping
- » Integrated 4G fallback 3G modem

OSM Recloser

Technical Specification

PART NUMBER	OSM15-16-800	OSM27-12-800	OSM38-12-800	OSM38-16-800⁴
Manufacturing Model	311/312/310 ^{1,2}	311/312/310 ^{1,2}	311/302/300 ^{1,2}	301/302/300 ^{1,2}
Current Sensing	3 x Current Transformers ³	3 x Current Transformers ³	3 x Current Transformers ³	3 x Current Transformers ³
Voltage Sensing	6 x Voltage Screens ³	6 x Voltage Screens ³	6 x Voltage Screens ³	6 x Voltage Screens ³
Rated Maximum Voltage	15.5kV	27kV	38kV	38kV
Rated Continuous Current	800A	800A	800A	800A
Fault Make Capacity RMS	16kA	12.5kA	12.5kA	16kA
Fault Make Capacity Peak	40kA	31.5kA	31.5kA	40kA
Fault Break Capacity	16kA	12.5kA	12.5kA	16kA
Mechanical / Full Load Operations	30,000	30,000	30,000	30,000
Fault Break Capacity Operations	70	140	100	140
Short Time Current Withstand	16kA/3 secs	16kA/3 secs	12.5kA/3 secs	16kA/3 secs

PART NUMBER	OSM15-16-800	OSM27-12-800	OSM38-12-800	OSM38-16-800 ⁴
Mainly Active Breaking Capacity	800A	800A	800A	800A
Cable Charging Current	25A	25A	40A	40A
Line Charging Current	5A	5A	5A	5A
Impulse Withstand Phase to Earth & Phase to Phase	110kV	150kV	195kV	200kV
Impulse Across the Interrupter	110kV	150kV	170kV	170kV
Power Frequency Withstand Phase to Earth (Dry)	50kV	60kV	70kV	70kV
Power Frequency Across the Interrupter	50kV	60kV	70kV	70kV
Ambient Temperature	-40°C to +55°C	-40°C to +55°C	-40°C to +55°C	-40°C to +55°C
Humidity	0-100%	0-100%	0-100%	0-100%
Altitude ⁴	3000m	3000m	3000m	3000m
Weight of the Tank (Three Phase)	100kg	109kg	150kg	150kg

1. A Switchgear model with matched CTs to provide 0.2A SEF sensitivity, is available for all 3 phase and 2 phase tanks.
2. OSM15-16-800-311, OSM27-12-800-311, OSM38-12-800-301, OSM38-16-800-301 (Single Phase Autorecloser) 1 x Current Transformers, 2x Voltage Screens, OSM15-16-800-312, OSM27-12-800-312, OSM38-12-800-302, OSM38-16-800-302 (Two Phase Autorecloser) 2 x Current Transformers, 4 x Voltage Screens
3. OSM38-16-800 tested at 40.5kV for interruption
4. Altitudes above 1000m should be corrected in accordance with ANSI C37.60-2012

NOJA POWER[®]

Empower the world.

NOJA Power Australia

CORPORATE OFFICE AND FACTORY

16 Archimedes Place, Murarrie, Brisbane Queensland, Australia 4172.

Phone: +61 (7) 3907 8777, Email: sales@nojapower.com.au

www.nojapower.com.au

NOJA Power Brazil

OFFICE AND FACTORY

NOJA Power do Brasil Ltda, Avenida Pierre Simon de Laplace, 965A Techno Park – Campinas – SP, Brasil

Phone: +55 (19) 3283 0041, Fax: +55 (19) 3283 0041, Email: vendas@nojapower.com.br

www.nojapower.com.br

NOJA Power USA

SALES OFFICE

NOJA Power LLC, Office: 333 SE 2nd Ave., Suite 2000, Miami, FL 33131, United States of America

Phone: +1 850 890 6724, Email: sales@nojapower.com

www.nojapower.com

NOJA Power UK

SALES OFFICE

NOJA Power Limited, Smart Zone 3, Tredomen Innovation & Technology Centre, Tredomen Park

Ystrad Mynach, Hengoed, South Wales, CF82 7FN, United Kingdom

Phone: +44 7487 557 599, Email: sales@nojapower.co.uk

www.nojapower.co.uk

NOJA Power USA, Canada and Caribbean

SALES OFFICE

NOJA Power LLC, 4 Strathbury Place SW, Calgary, AB, T3H1M7, Canada

Phone: +1 587 896 8533, Email: sales@nojapower.com

www.nojapower.com

Distributor: